

le

a

lea

e

lee

i

lei

o

leo

u

leu

قناة المدرس المغربي



C

a

ca

e

ce

i

ci

o

co

u

cu

قناة المدرس المغربي



d

a

da

e

de

i

di

o

do

u

du

قناة المدرس المغربي



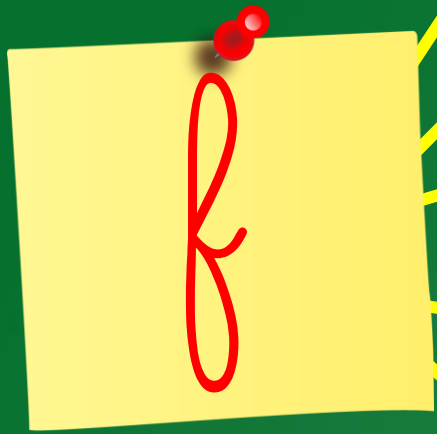

a



fa

e



fe

i



fi

o



fo

u



fu

قناة المدرس المغربي



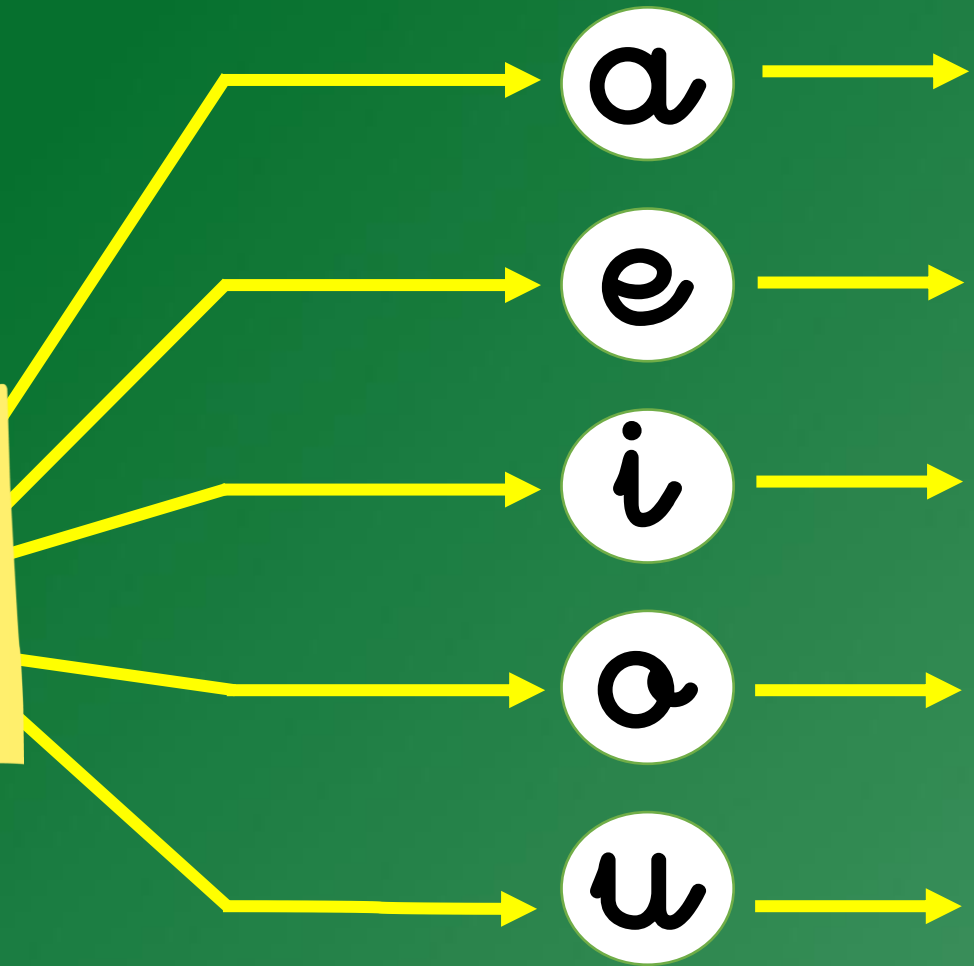
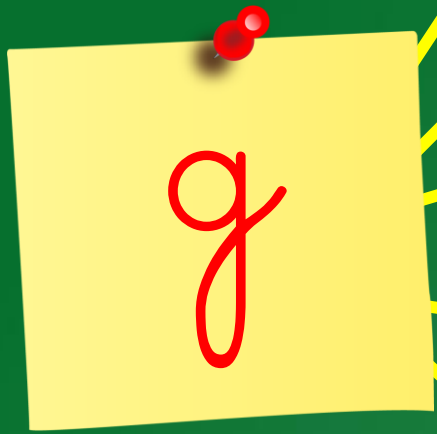

ga

ge

gi

go

gu

قناة المدرس المغربي



قناة المدرس المغربي

gn

a

gna

e

gne

i

gni

o

gno

u

gnu

قناة المدرس المغربي



h

a

ha

e

he

i

hi

o

ho

u

hu

قناة المدرس المغربي



ch

a

cha

e

che

i

chi

o

cho

u

chu

قناة المدرس المغربي



j

a

ja

e

je

i

ji

o

jo

u

ju

قناة المدرس المغربي



h

a

ka

e

ke

i

ki

o

ko

u

ku

قناة المدرس المغربي



e

a

la

e

le

i

li

o

lo

u

lu

قناة المدرس المغربي



m

a

ma

e

me

i

mi

o

mo

u

mu

قناة المدرس المغربي



ن

ا

na

e

ne

i

ni

o

no

u

nu

قناة المدرس المغربي



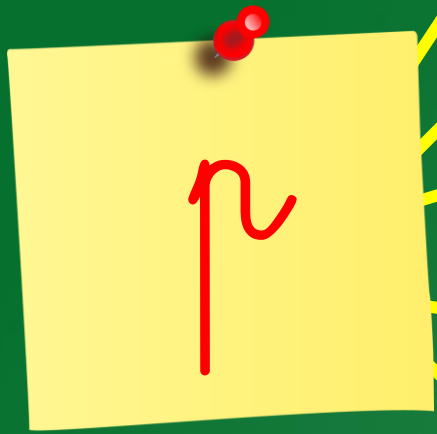

a



ra

e



re

i



ri

o



ro

u



ru

قناة المدرس المغربي



ph

a

pha

e

phe

i

phi

o

pho

u

phu

قناة المدرس المغربي



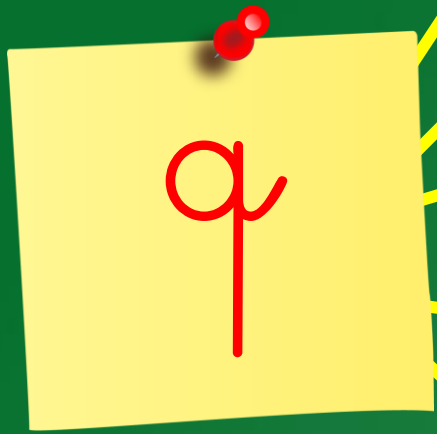

ا



qa

e



qe

i



qi

o



qo

u



qu

قناة المدرس المغربي



qu

a

qua

e

que

o

quo

i

qui

قناة المدرس المغربي



ر

a

ra

e

re

i

ri

o

ro

u

ru

قناة المدرس المغربي



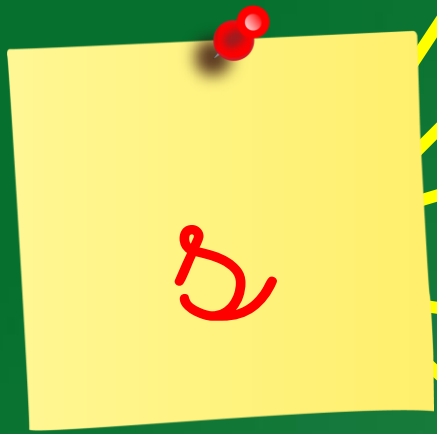

ا

سا

ع

سع

ي

سي

و

سو

ط

سط

قناة المدرس المغربي



قناة المدرس المغربي

ت

ا

تا

ة

ته

ي

تي

و

تو

و

تو

قناة المدرس المغربي



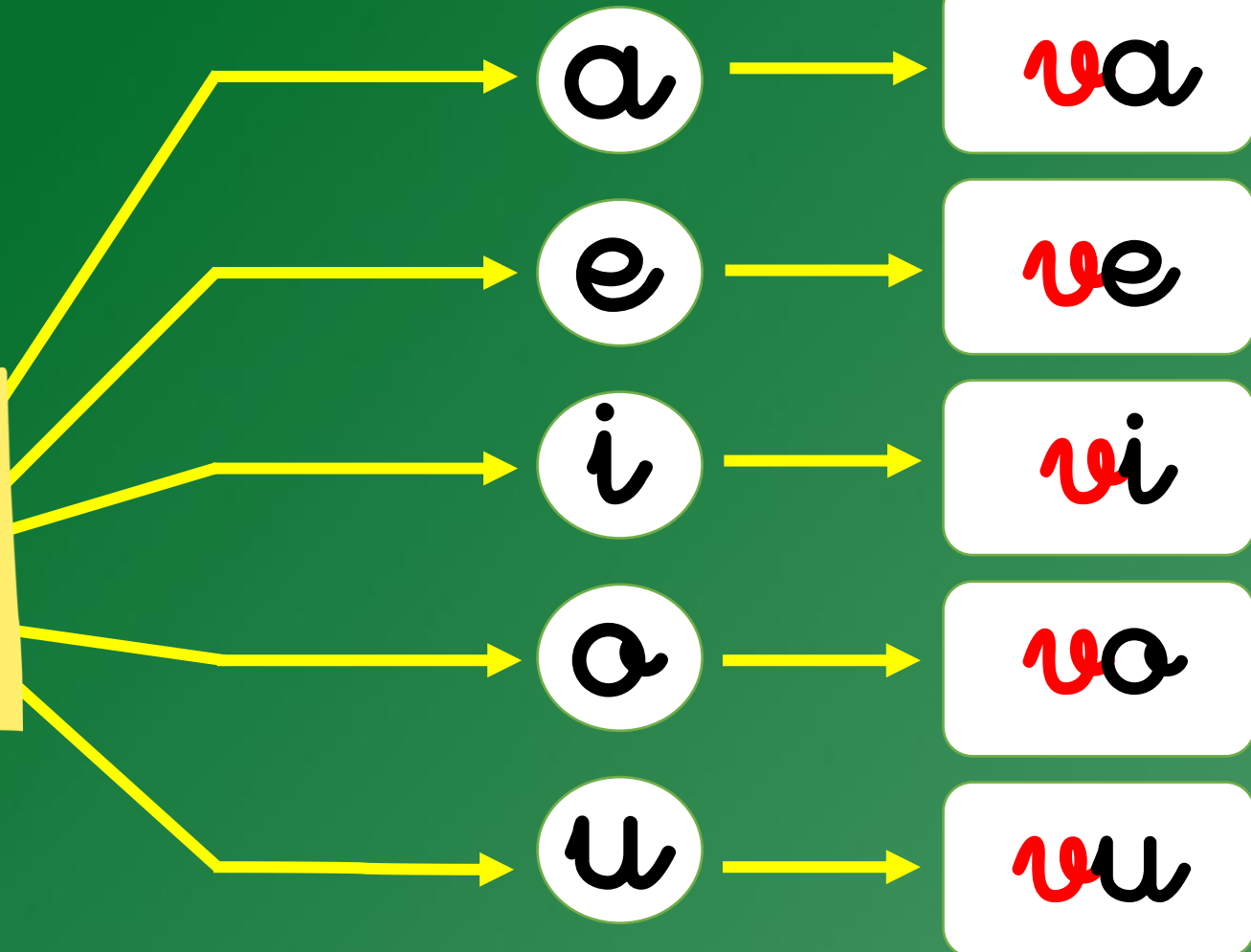
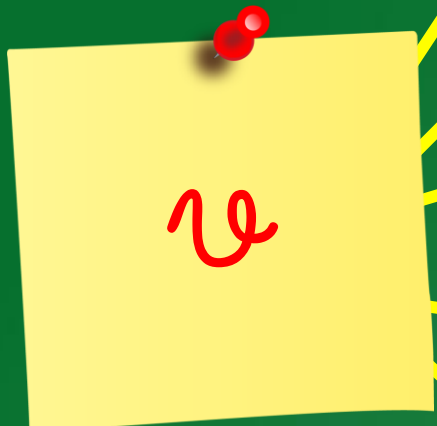

قناة المدرس المغربي



قناة المدرس المغربي

و

a

wa

e

we

i

wi

o

wo

u

wu

قناة المدرس المغربي



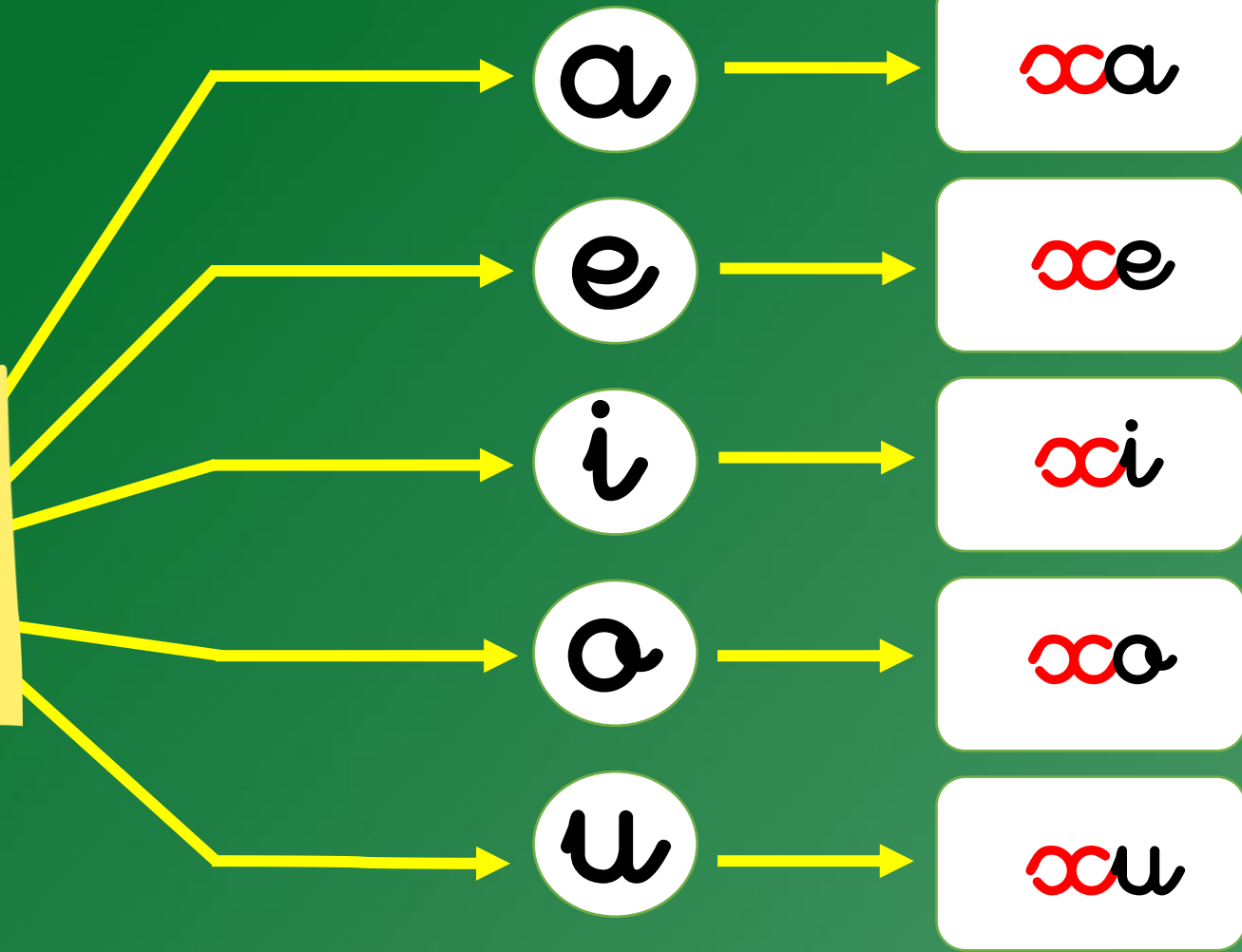
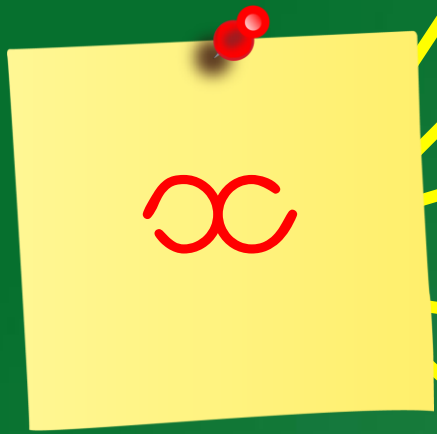

قناة المدرس المغربي





ا

za

ة

ze

ي

zi

و

zo

و

zu

قناة المدرس المغربي



قناة المدرس المغربي

le

é

lé

è

lè

ê

lê

قناة المدرس المغربي



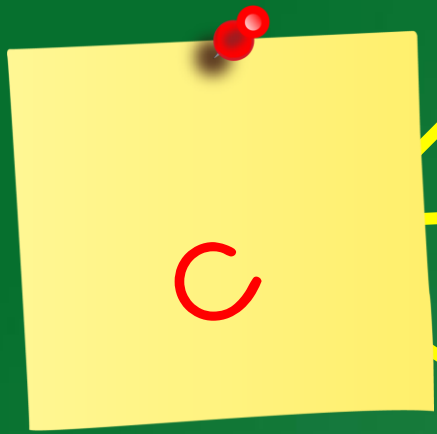

é

cé

è

cè

ê

cê

قناة المدرس المغربي



d

é

dé

è

dè

ê

dê

قناة المدرس المغربي



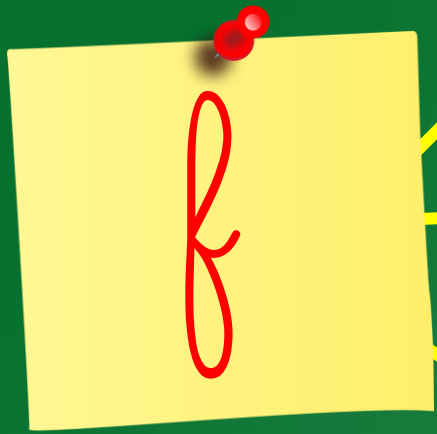

رَ

رَ

رِ

رِ

رُ

رُ

قناة المدرس المغربي





é

gé

è

gè

ê

gê

قناة المدرس المغربي



قناة المدرس المغربي

gn

é

gné

è

gnè

ê

gnê



h

é

hé

è

hè

ê

hê

قناة المدرس المغربي



ch

é

ché

è

chè

ê

chê



j

é

je

è

je

ê

je

قناة المدرس المغربي



h

é

hé

è

hè

ê

hê

قناة المدرس المغربي



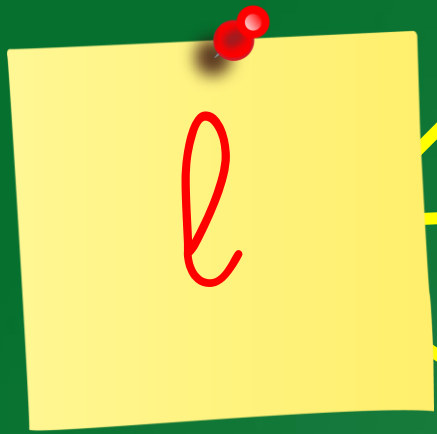

é

lé

è

lè

ê

lê

قناة المدرس المغربي



m

é

mé

è

mè

ê

mê

قناة المدرس المغربي



n

é

né

è

nè

ê

nê

قناة المدرس المغربي



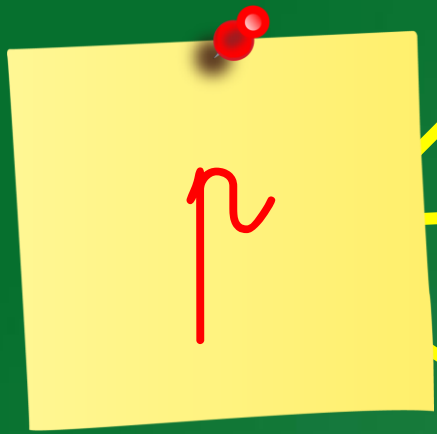

é



ré

è



rè

ê



rê

قناة المدرس المغربي



ph

é

phé

è

phè

ê

phê



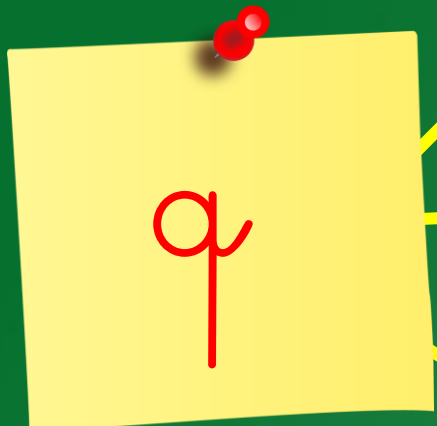

é



qué

è



què

ê



quê

قناة المدرس المغربي



qu

é

qué

è

què

ê

quê



ر

é

رَé

è

رَè

ê

رَê

قناة المدرس المغربي



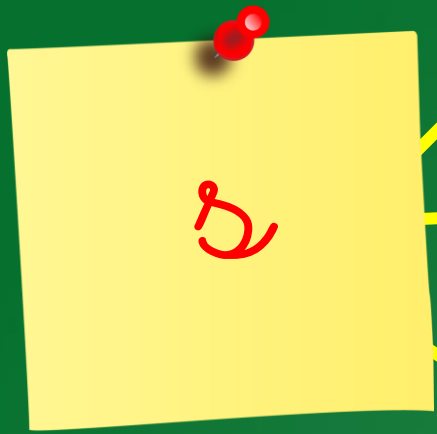

هَ

هَ

هَ

هَ

هَ

هَ

قناة المدرس المغربي



ت

é

تَé

è

تَè

ê

تَê

قناة المدرس المغربي





وُ

وُ

وِ

وِ

وِ

وِ

قناة المدرس المغربي



و

é

وé

è

وè

ê

وê

قناة المدرس المغربي



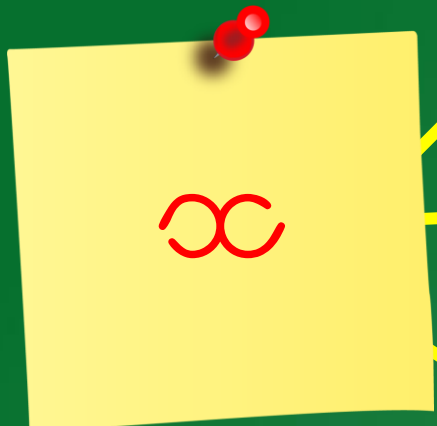

عَ

عَ

عِ

عِ

عِ

عِ

قناة المدرس المغربي





زَ

زَé

زَè

زَè

زَê

زَê

قناة المدرس المغربي



Le son [e]

le

é



bé

er



ber

es



bes

et



bet

ery



bery

قناة المدرس المغربي



Le son [e]

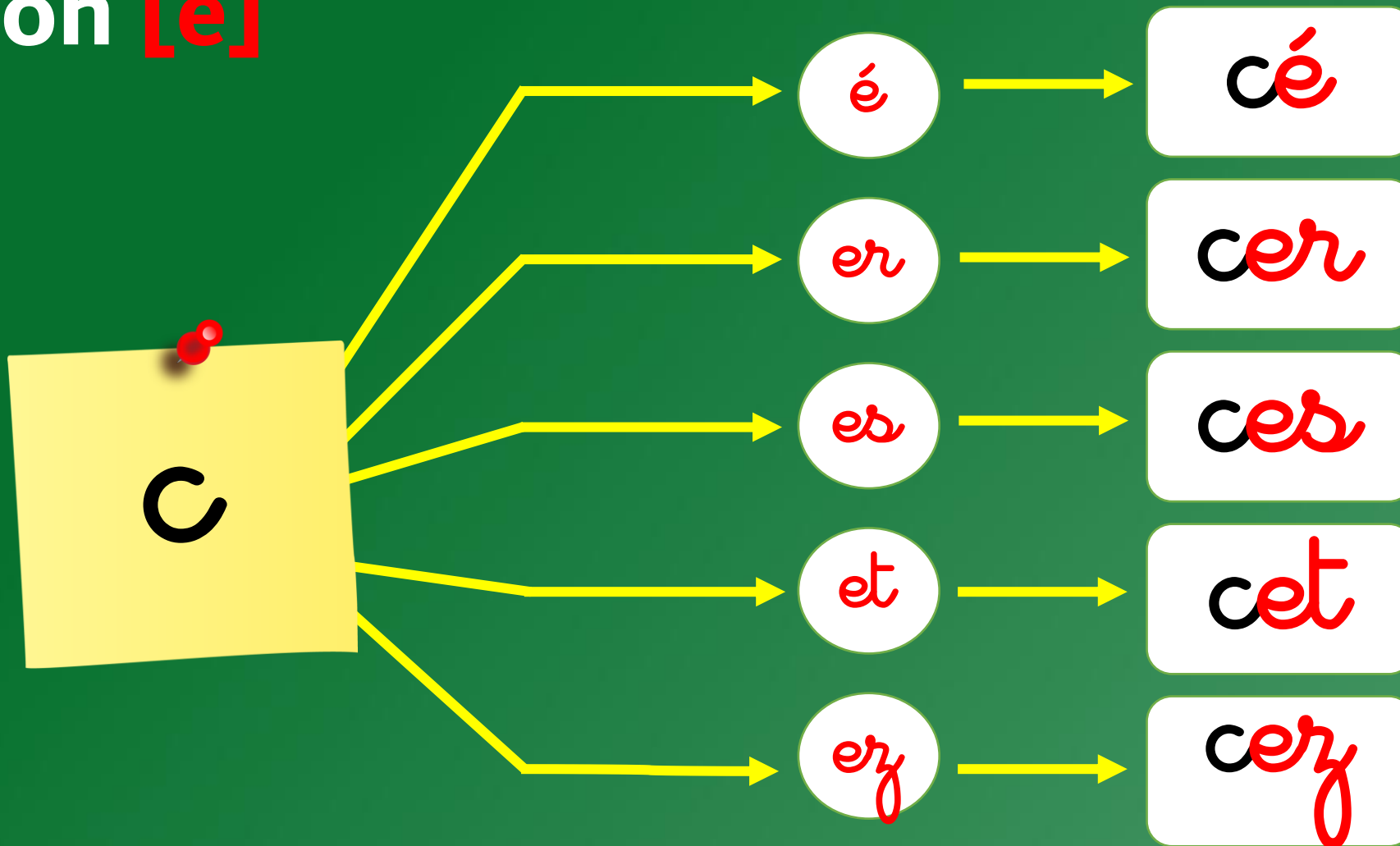

قناة المدرس المغربي



Le son [e]

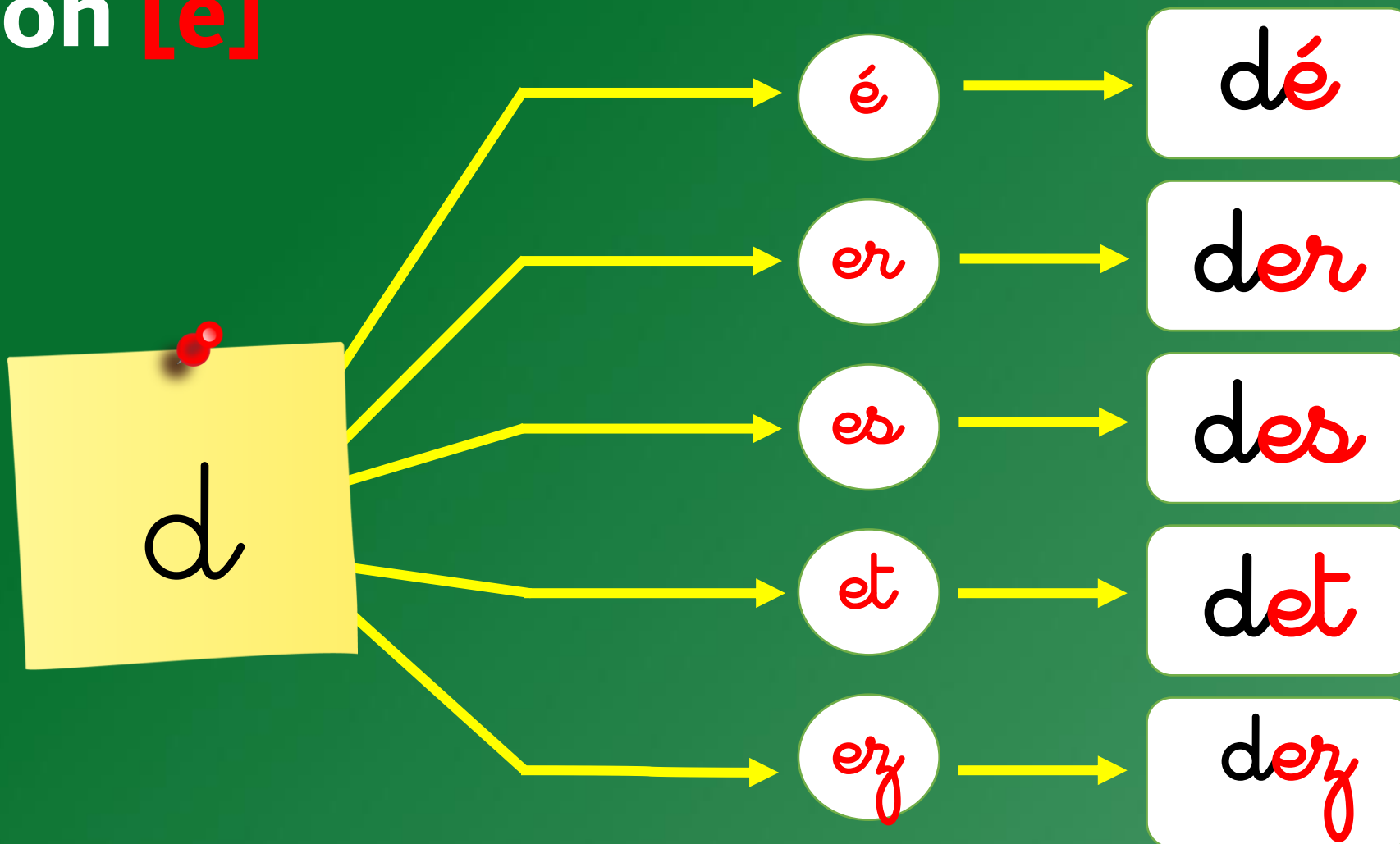

قناة المدرس المغربي



Le son [e]

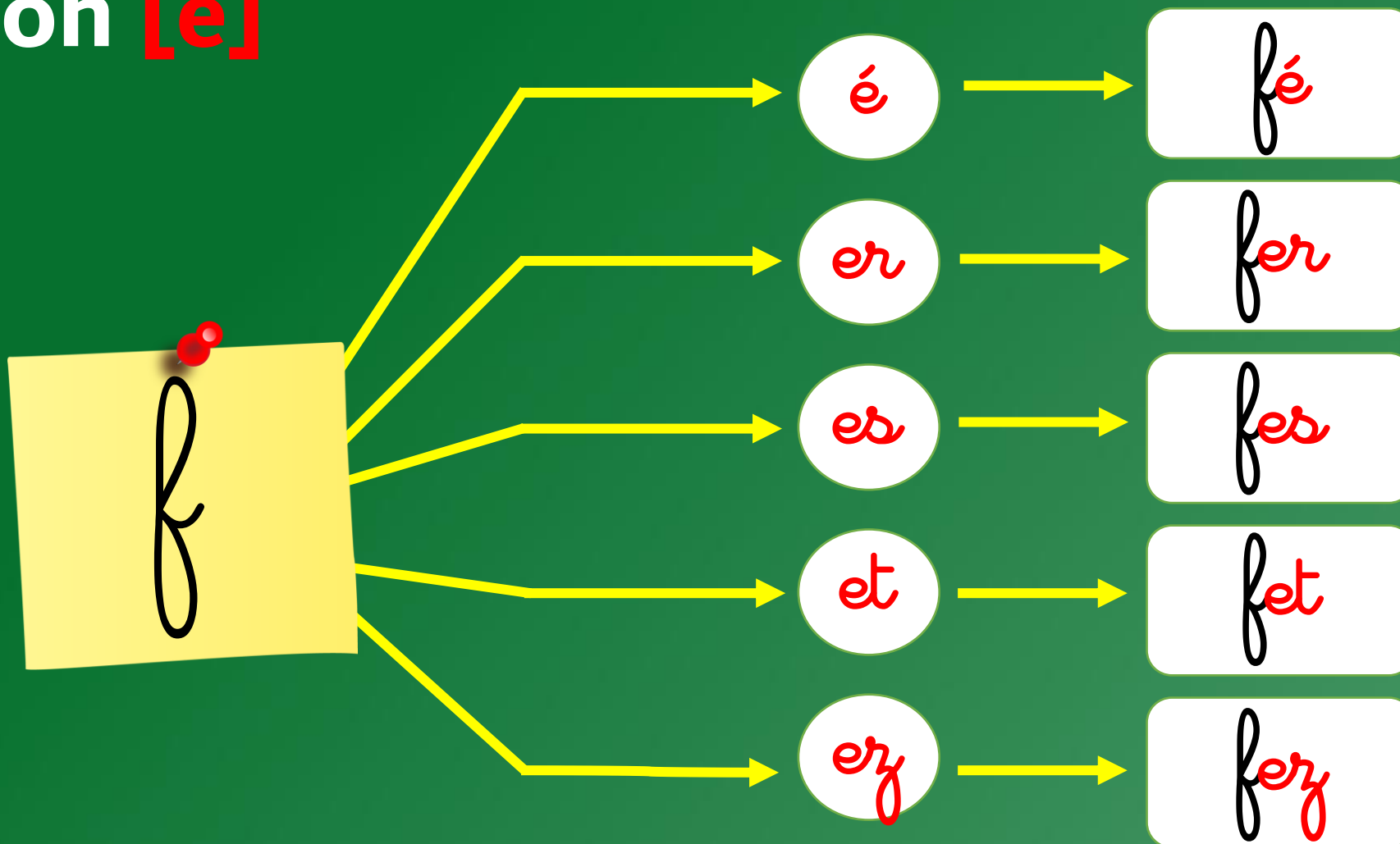

قناة المدرس المغربي



Le son [e]

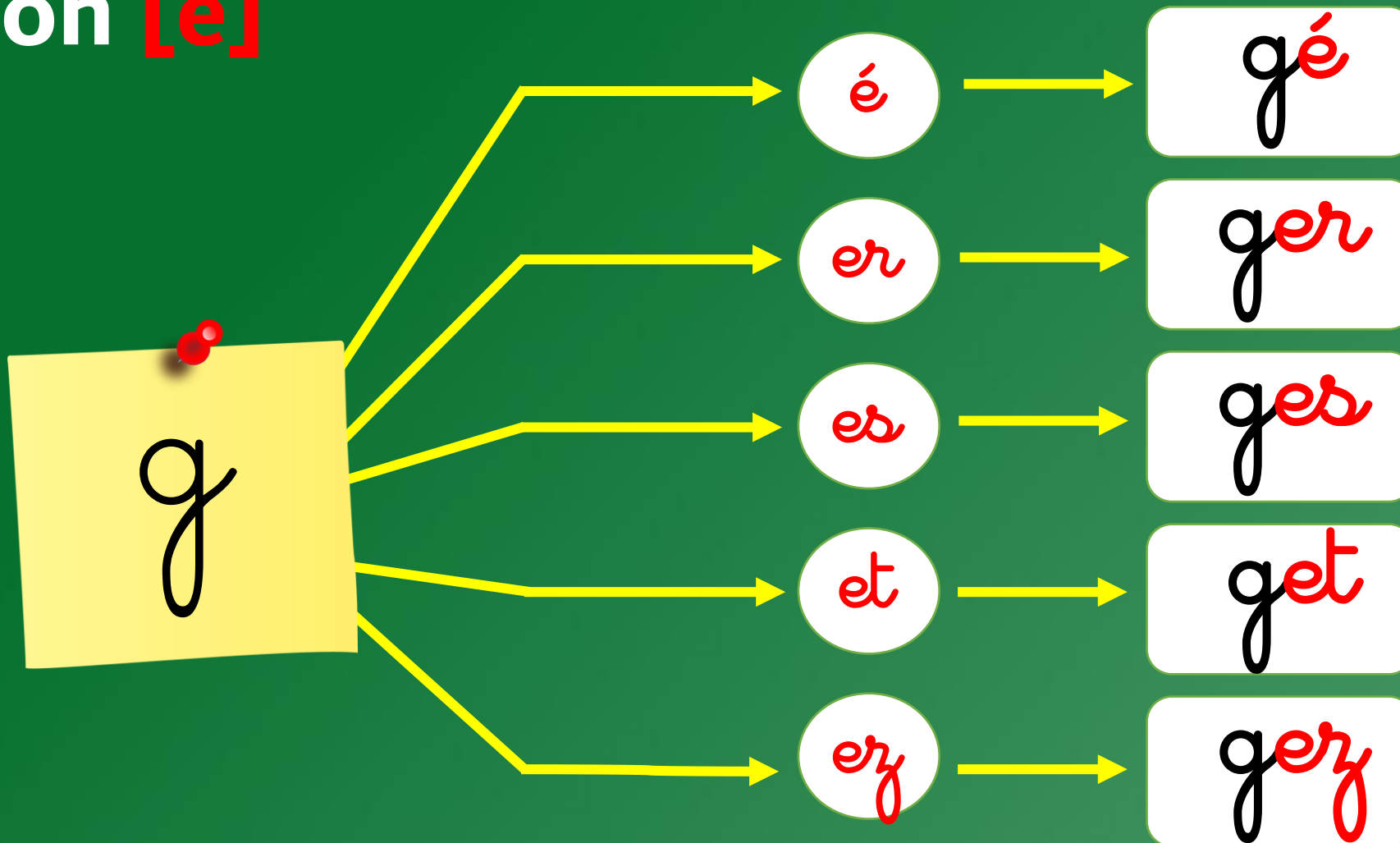

قناة المدرس المغربي



Le son [e]

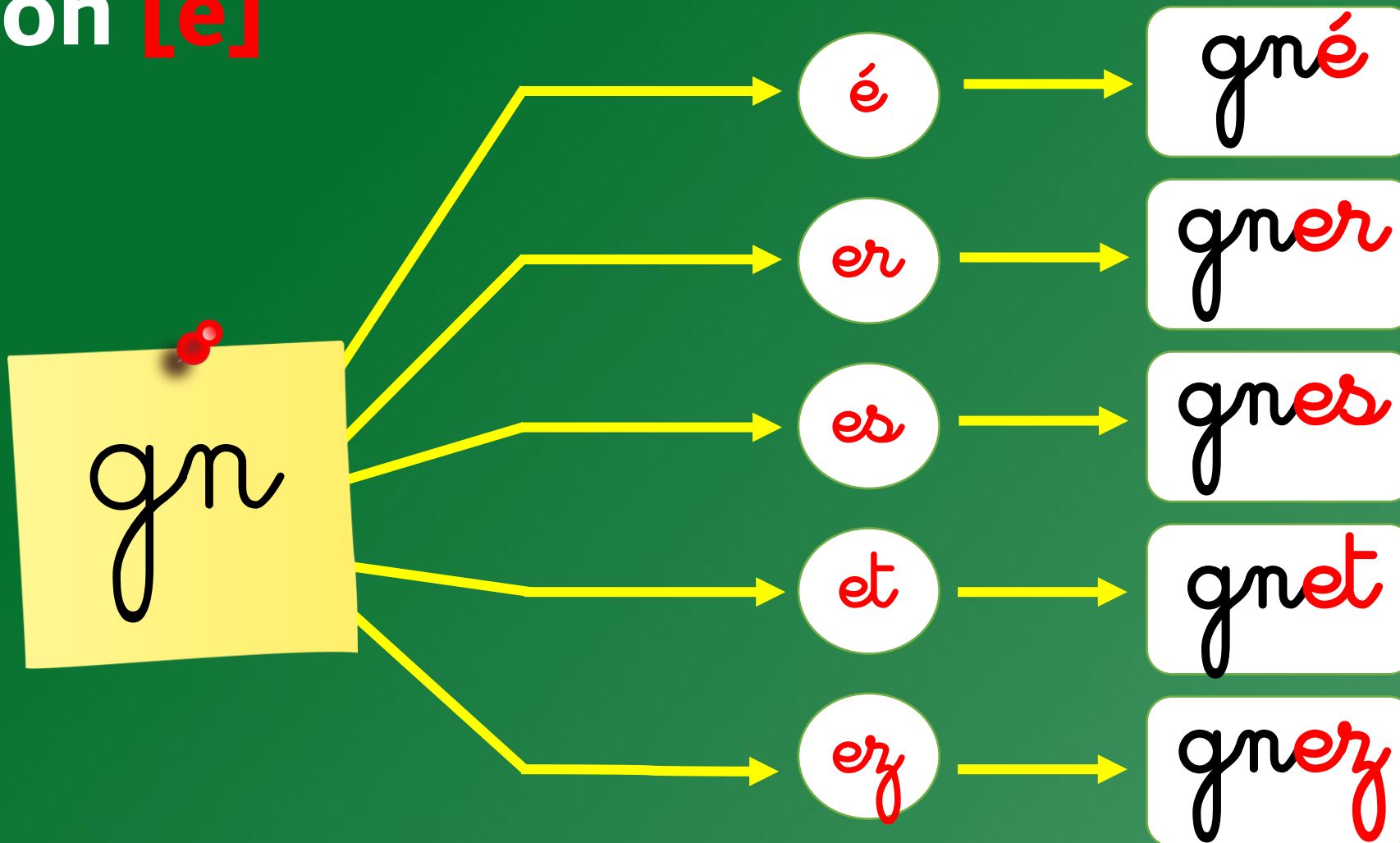

Le son [e]

h

é

hé

er

her

es

hes

et

het

ery

hery

قناة المدرس المغربي



Le son [e]

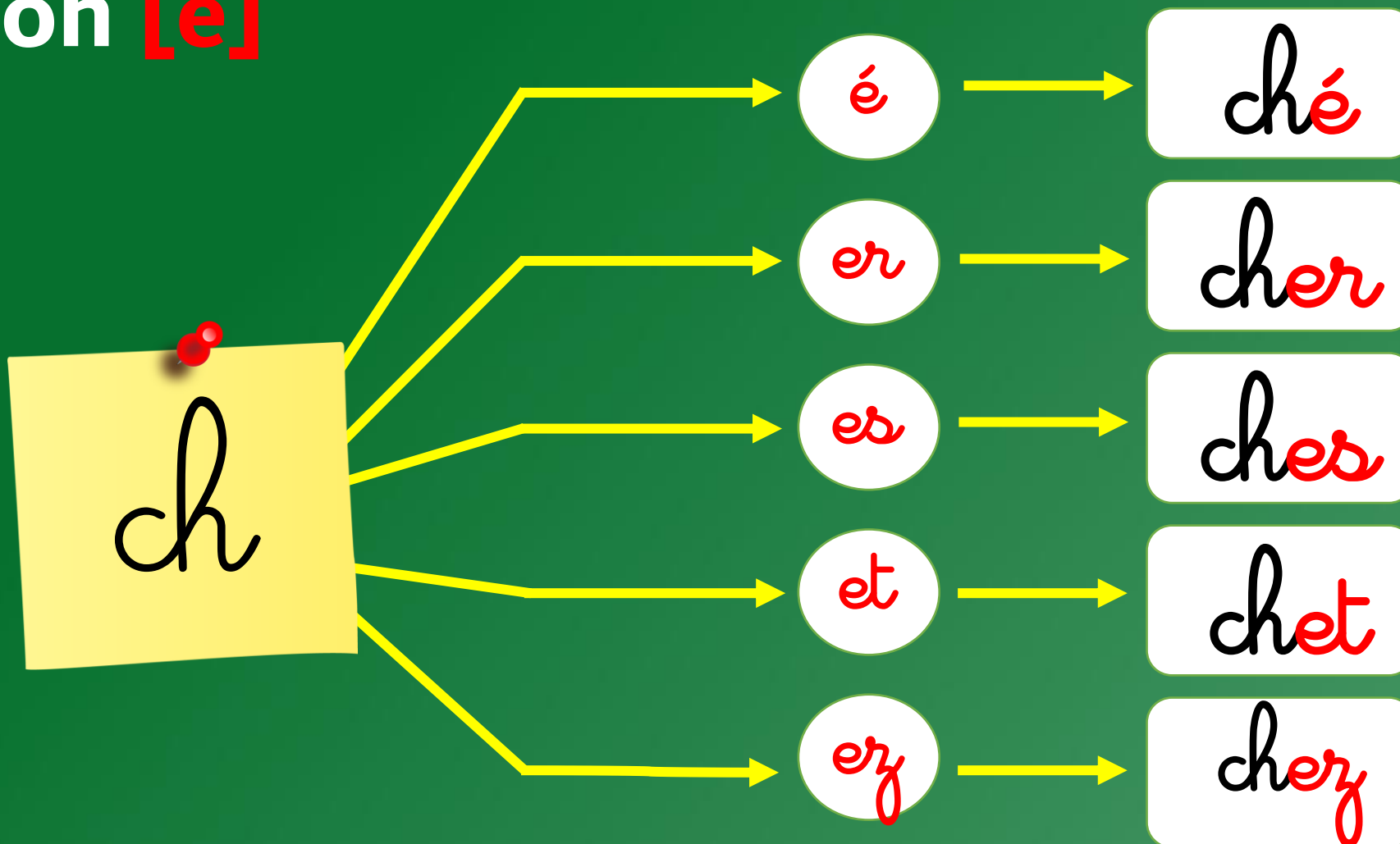

قناة المدرس المغربي



Le son [e]

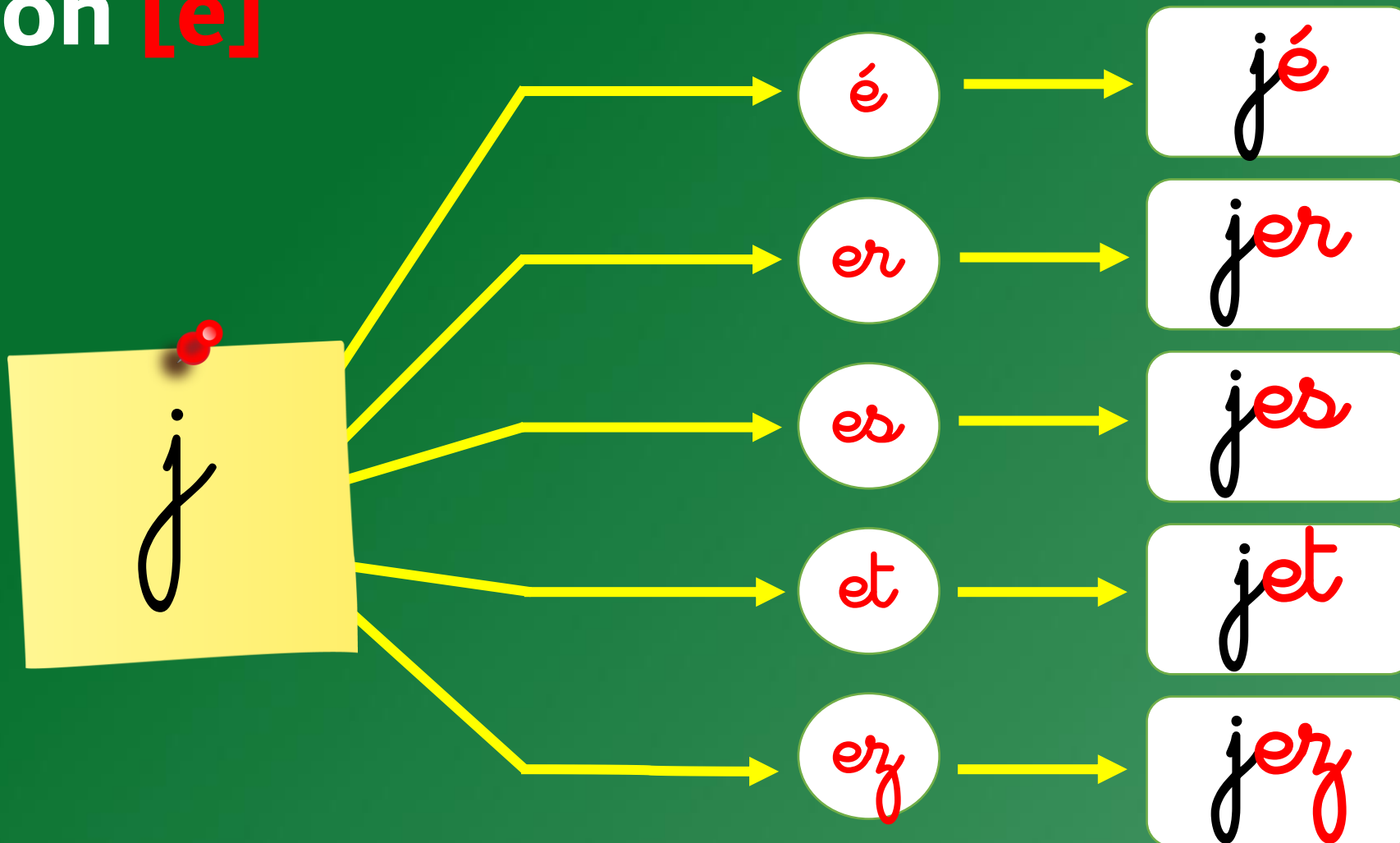

Le son [e]

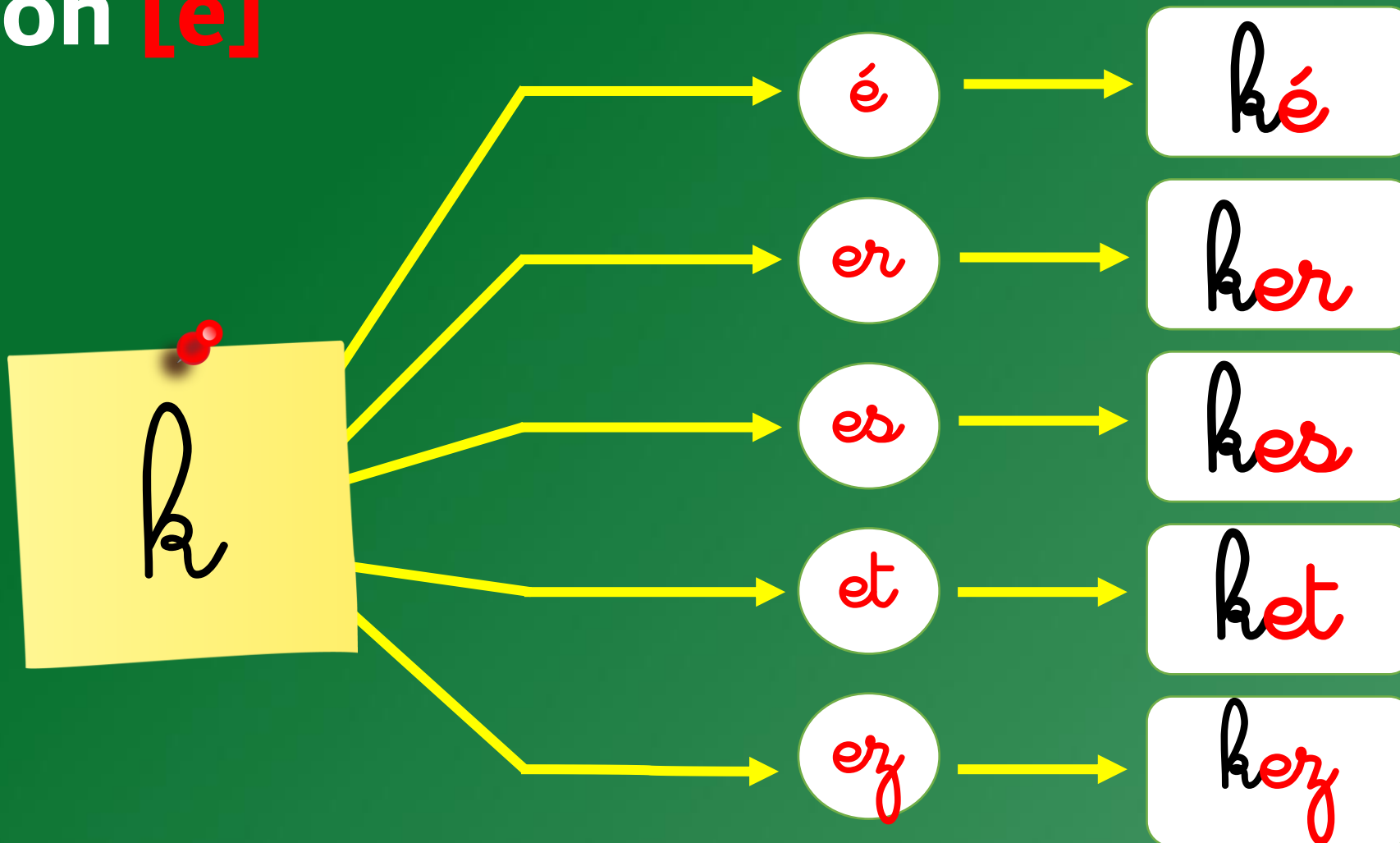

قناة المدرس المغربي



Le son [e]

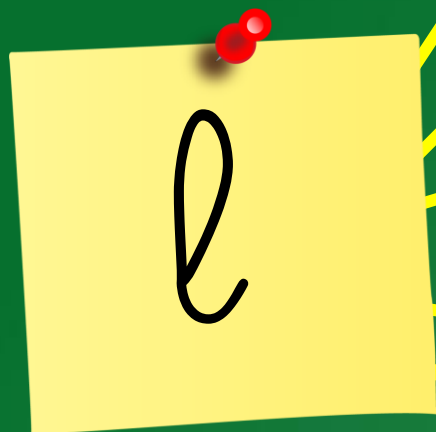

é



lé

er



ler

es



les

et



let

ery



lery

قناة المدرس المغربي



Le son [e]

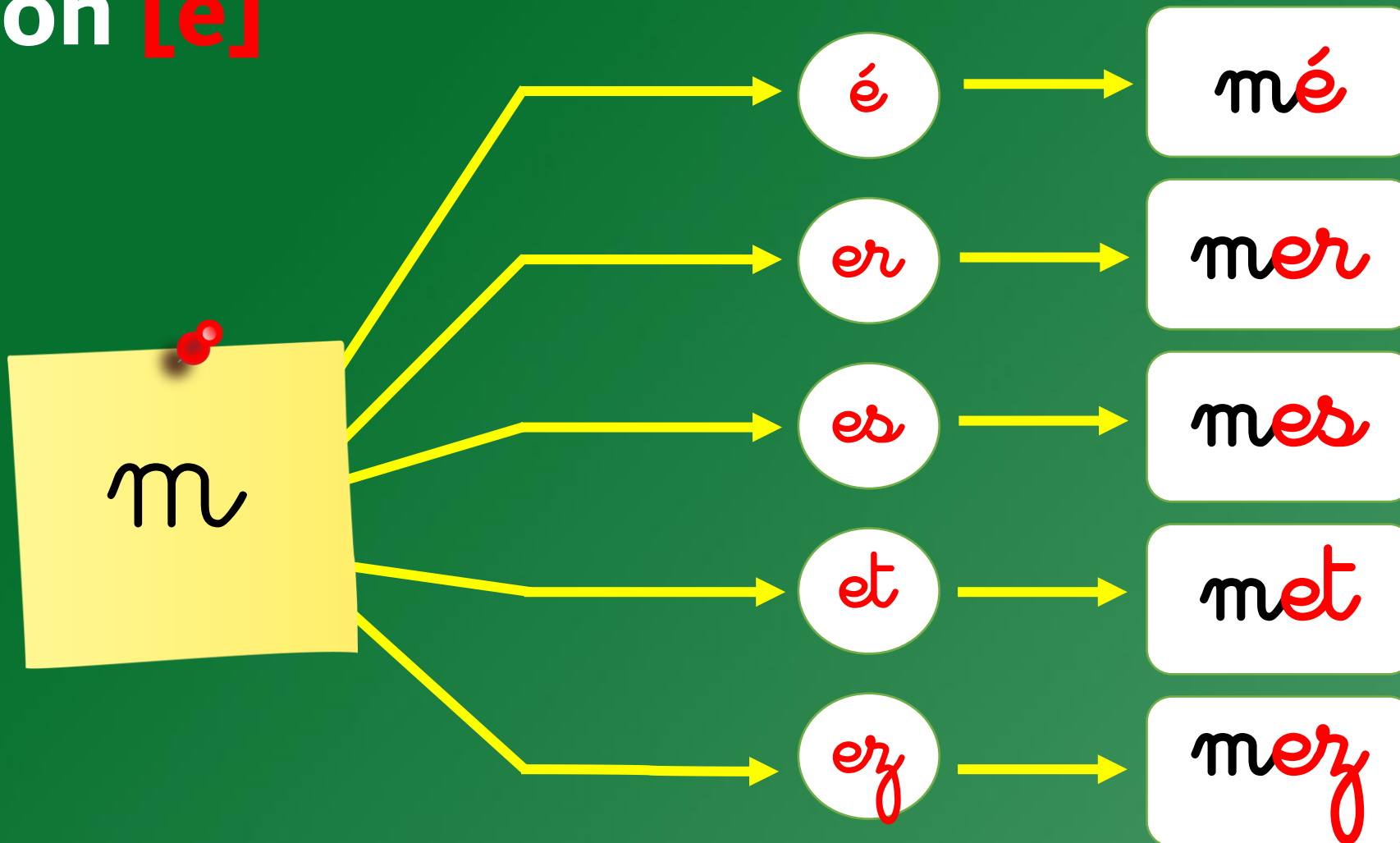

قناة المدرس المغربي



Le son [e]

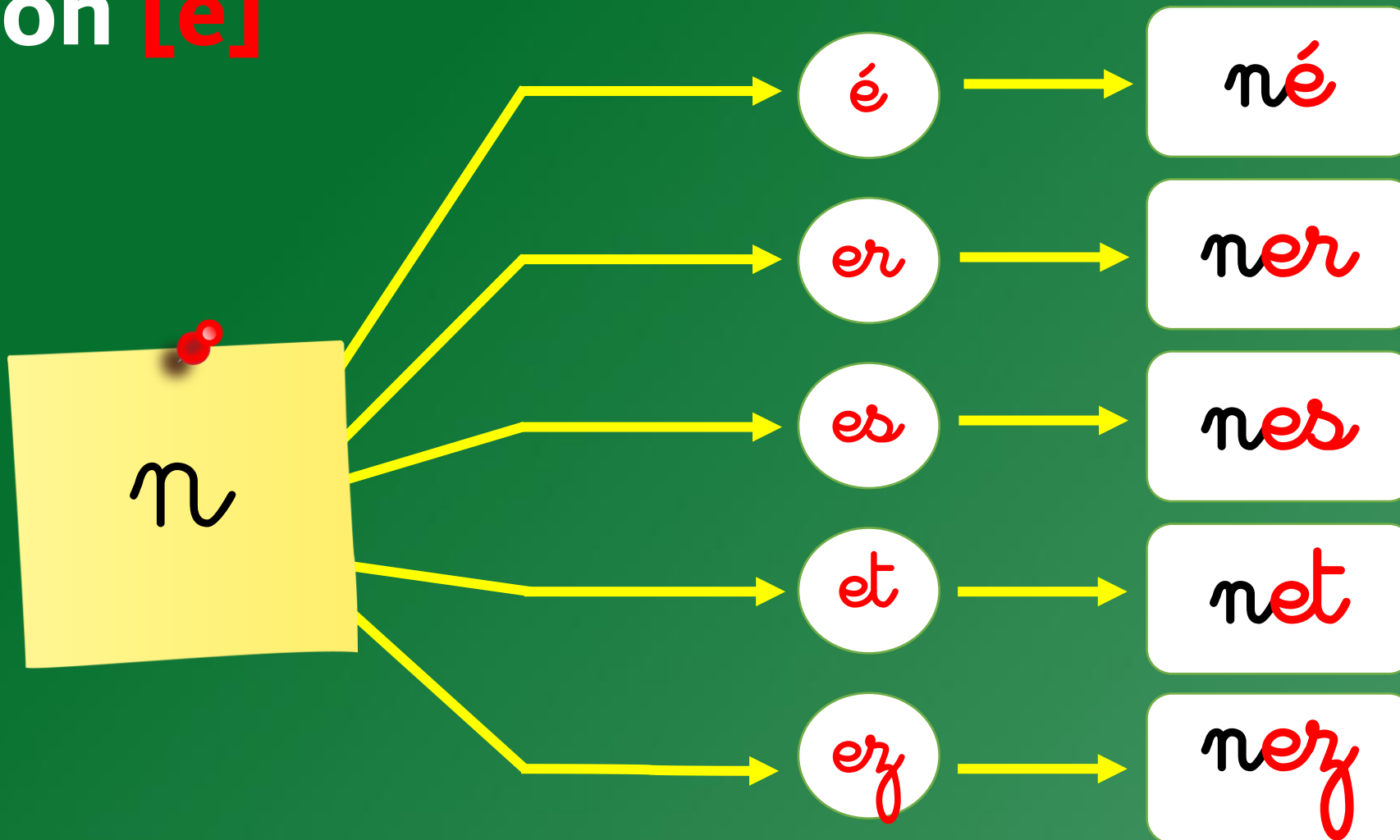

Le son [e]

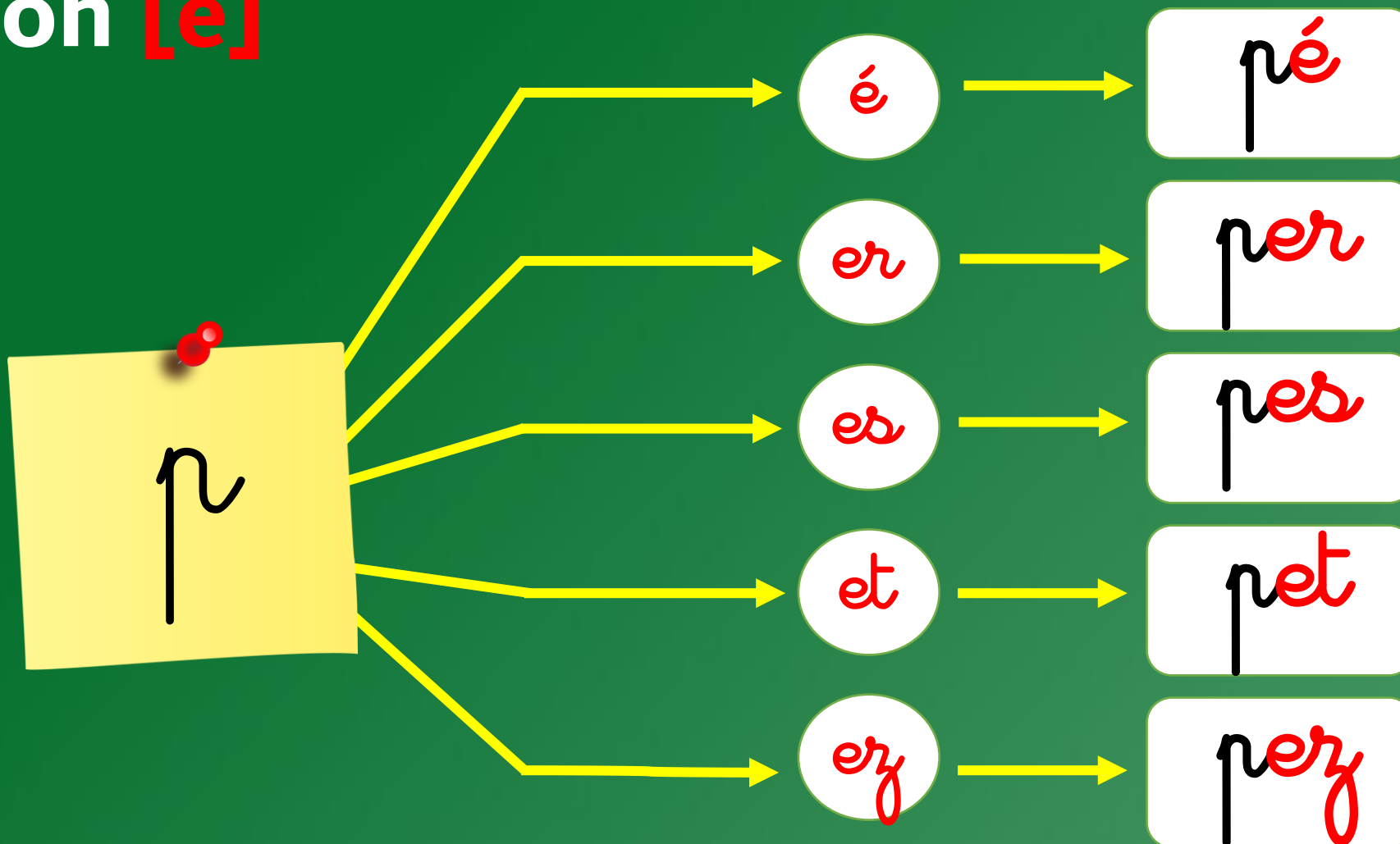

قناة المدرس المغربي



Le son [e]

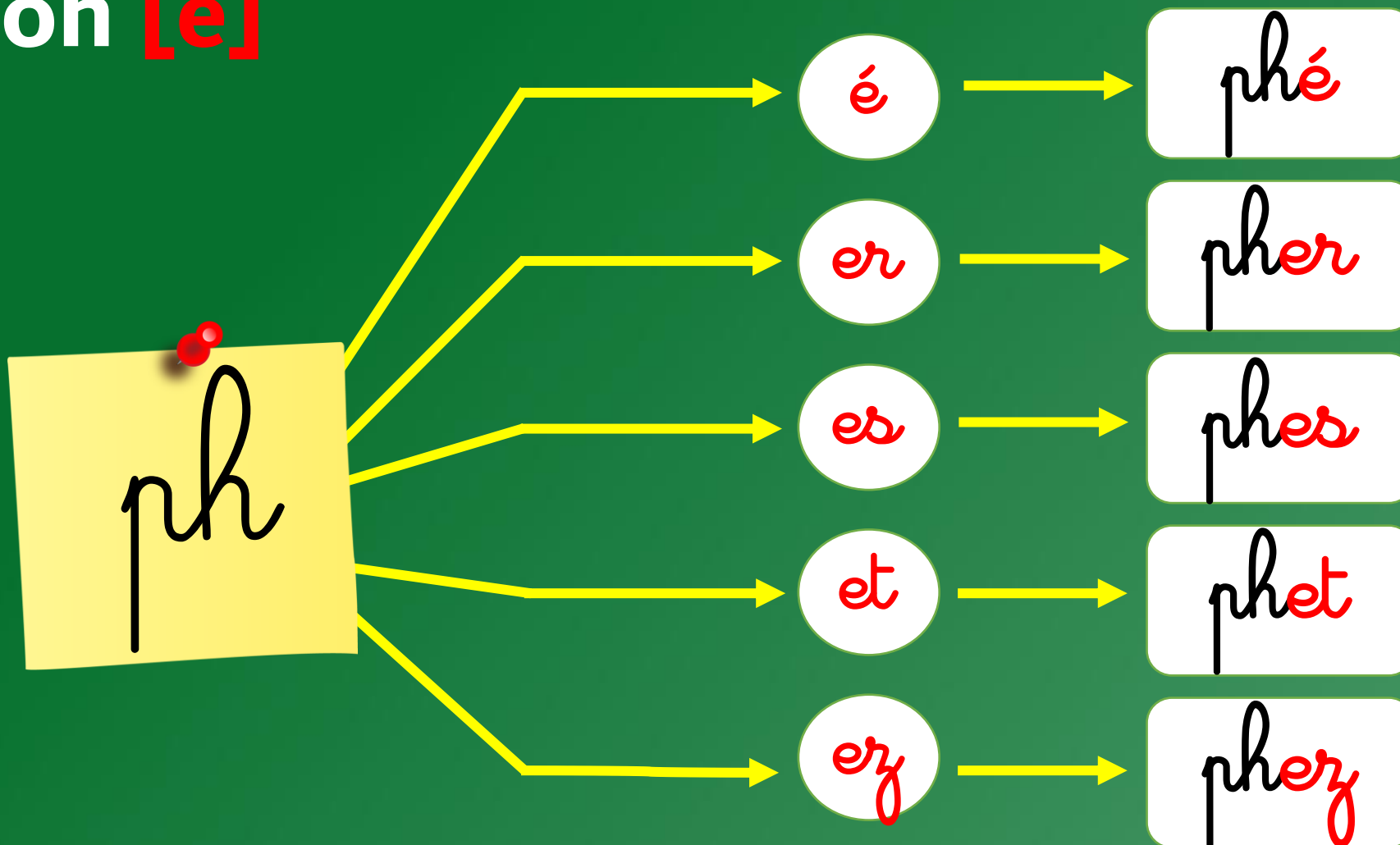

قناة المدرس المغربي



Le son [e]

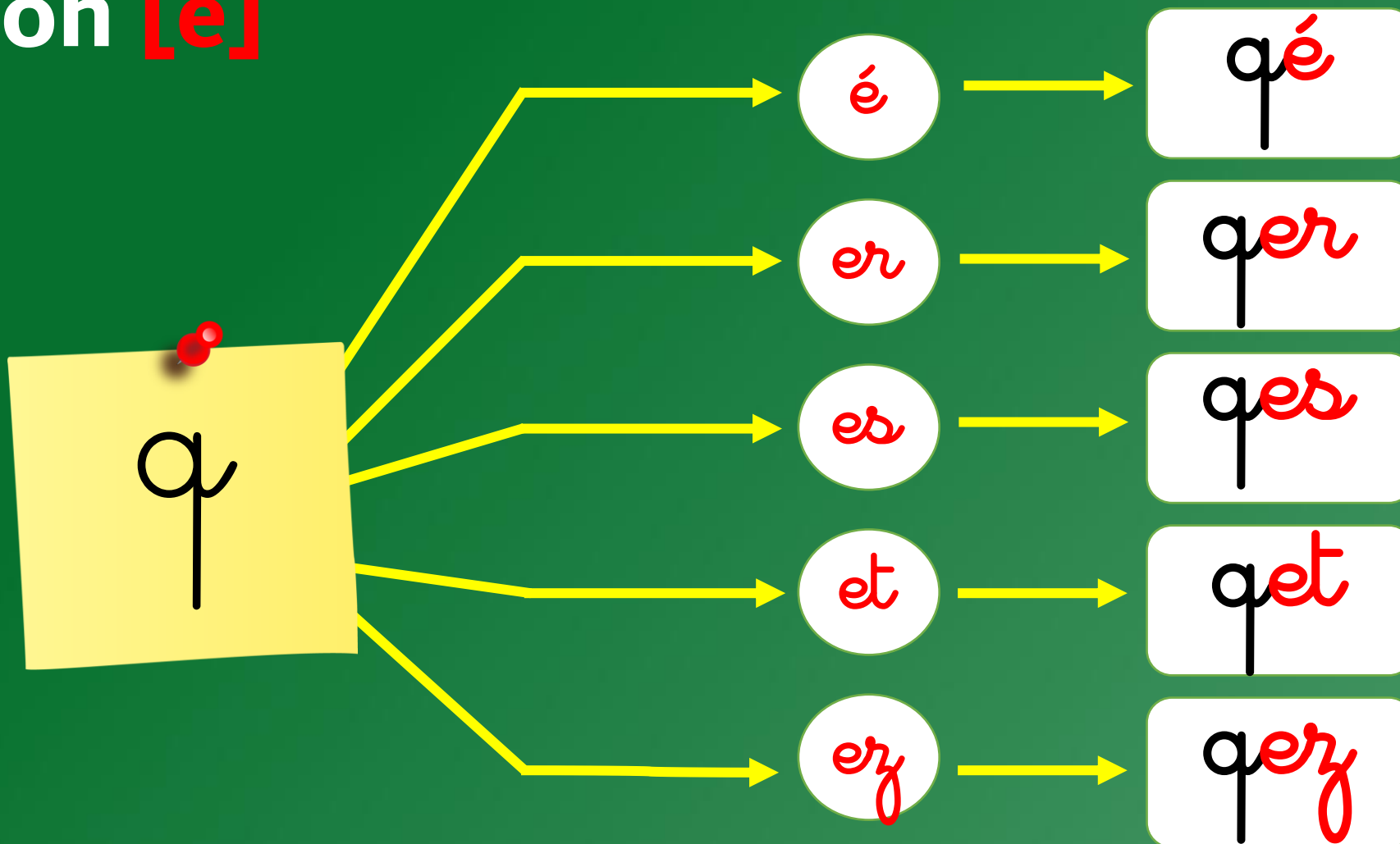

قناة المدرس المغربي



Le son [e]

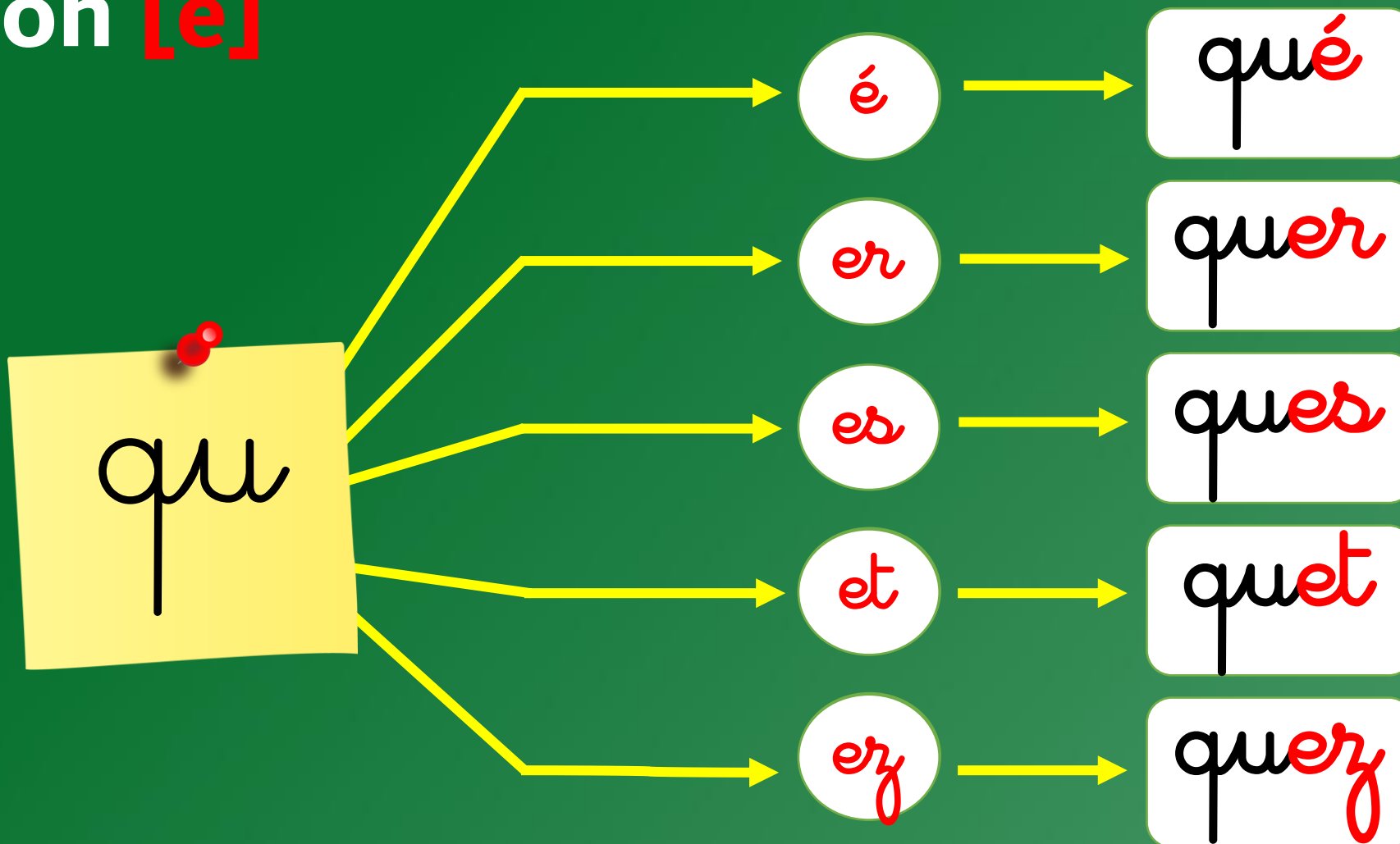

قناة المدرس المغربي



Le son [e]

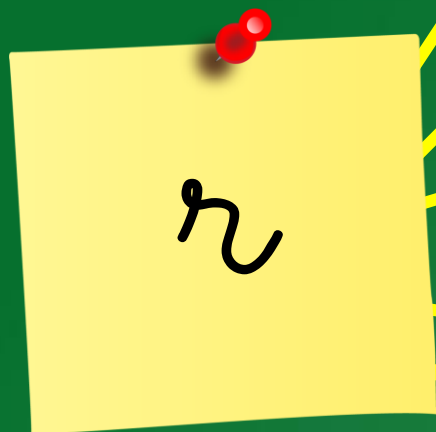

é

ré

er

rer

es

res

et

ret

ery

very

قناة المدرس المغربي



Le son [e]

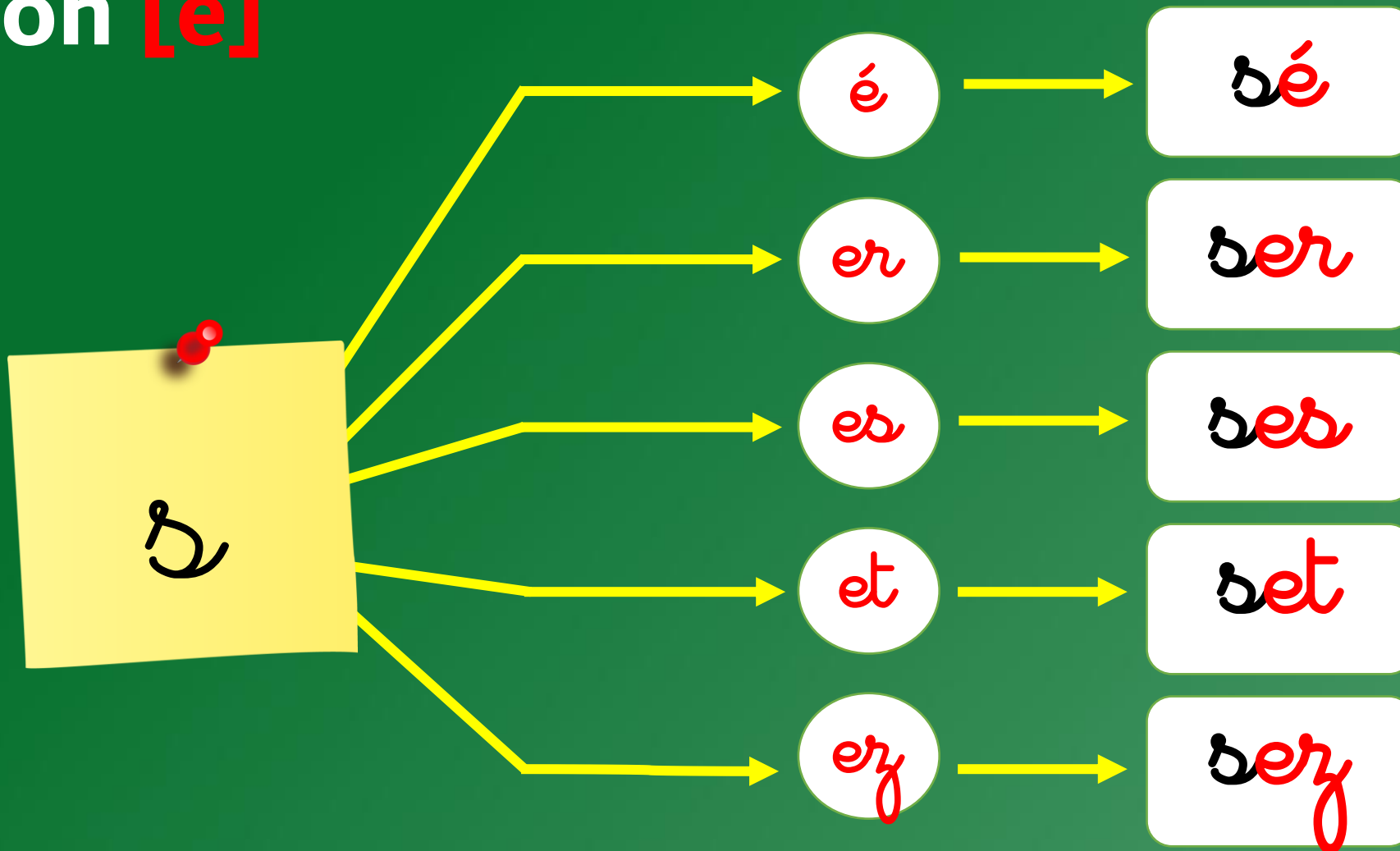

قناة المدرس المغربي



Le son [e]

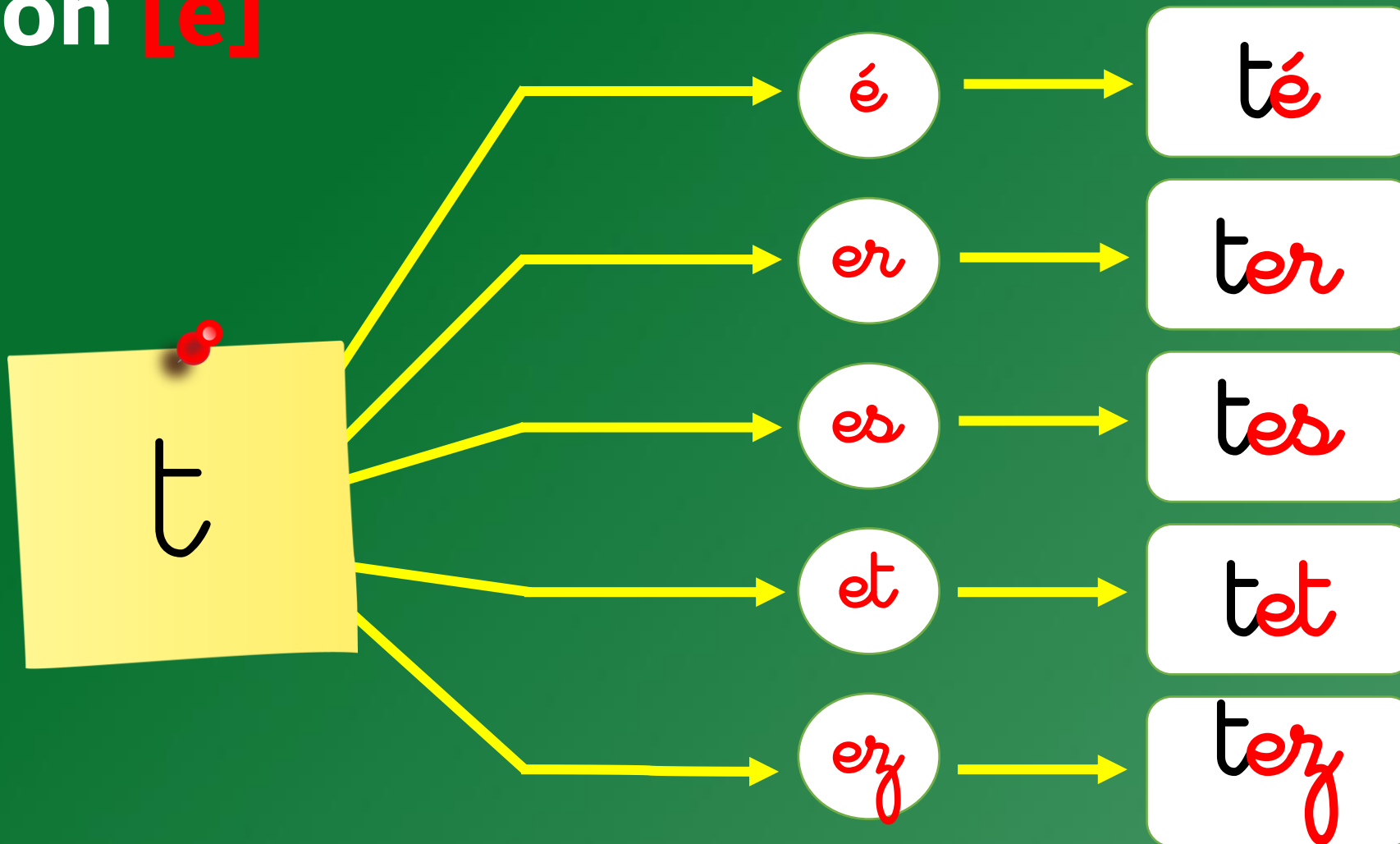

Le son [e]

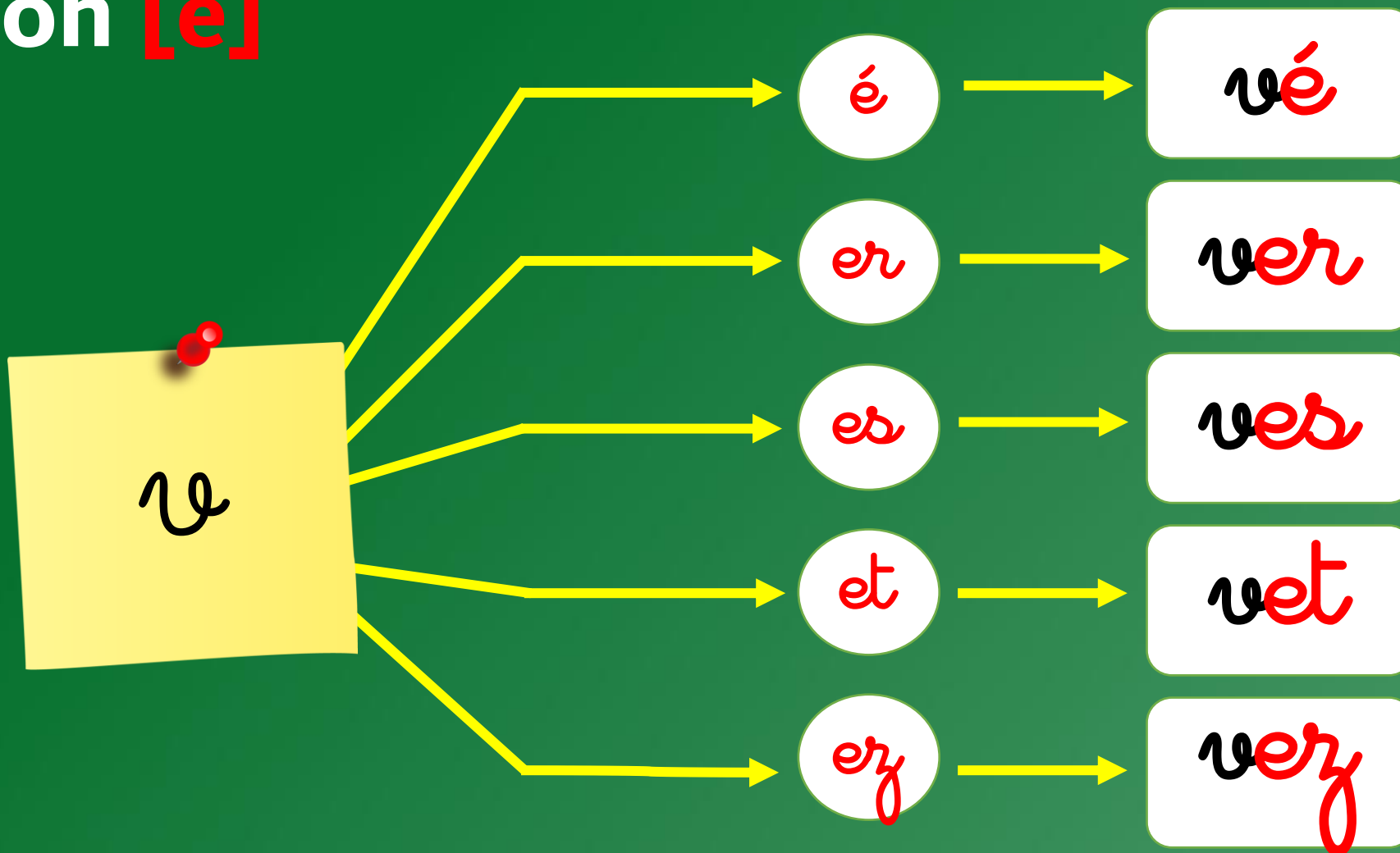

قناة المدرس المغربي



Le son [e]

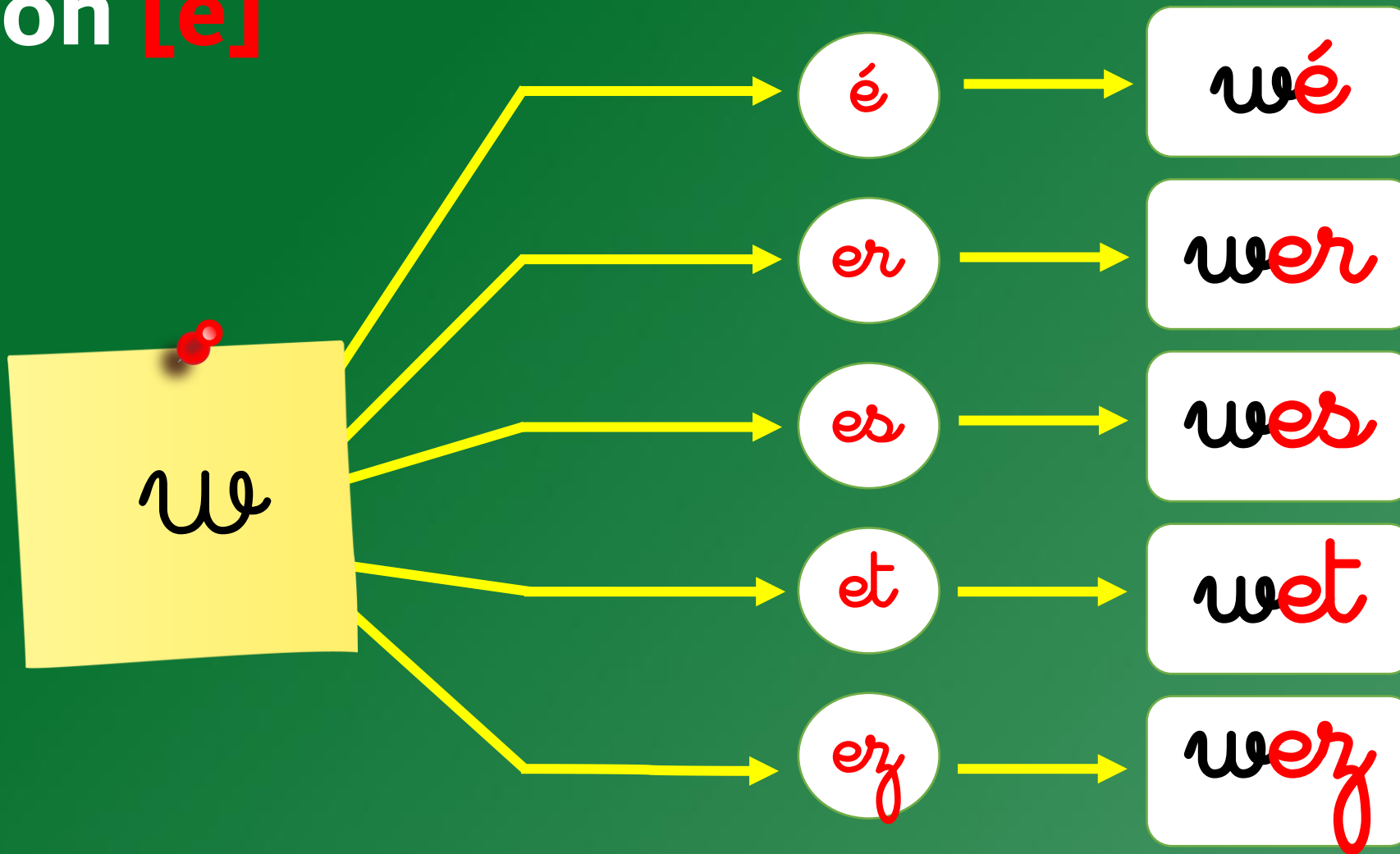

Le son [e]

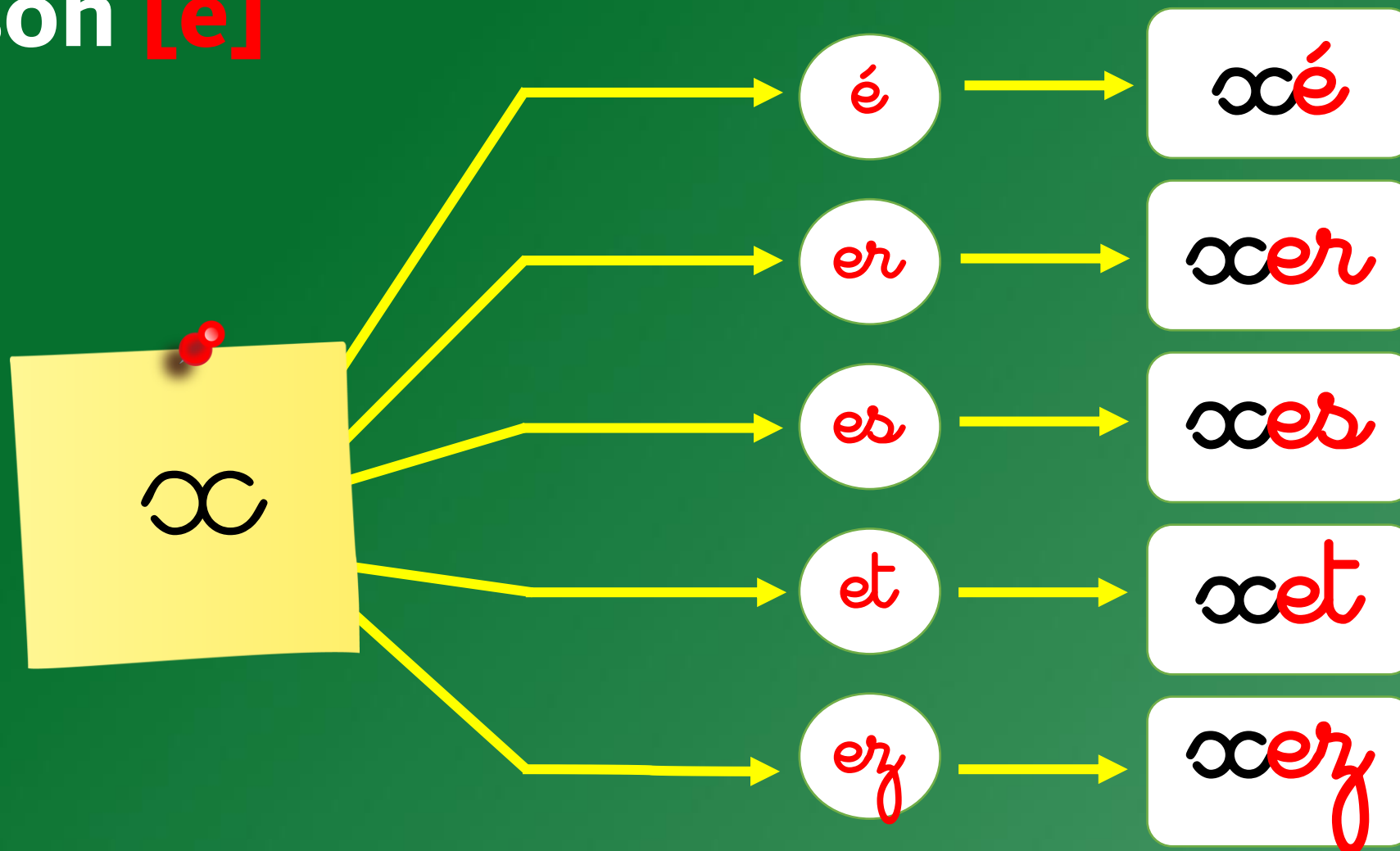

قناة المدرس المغربي



Le son [e]

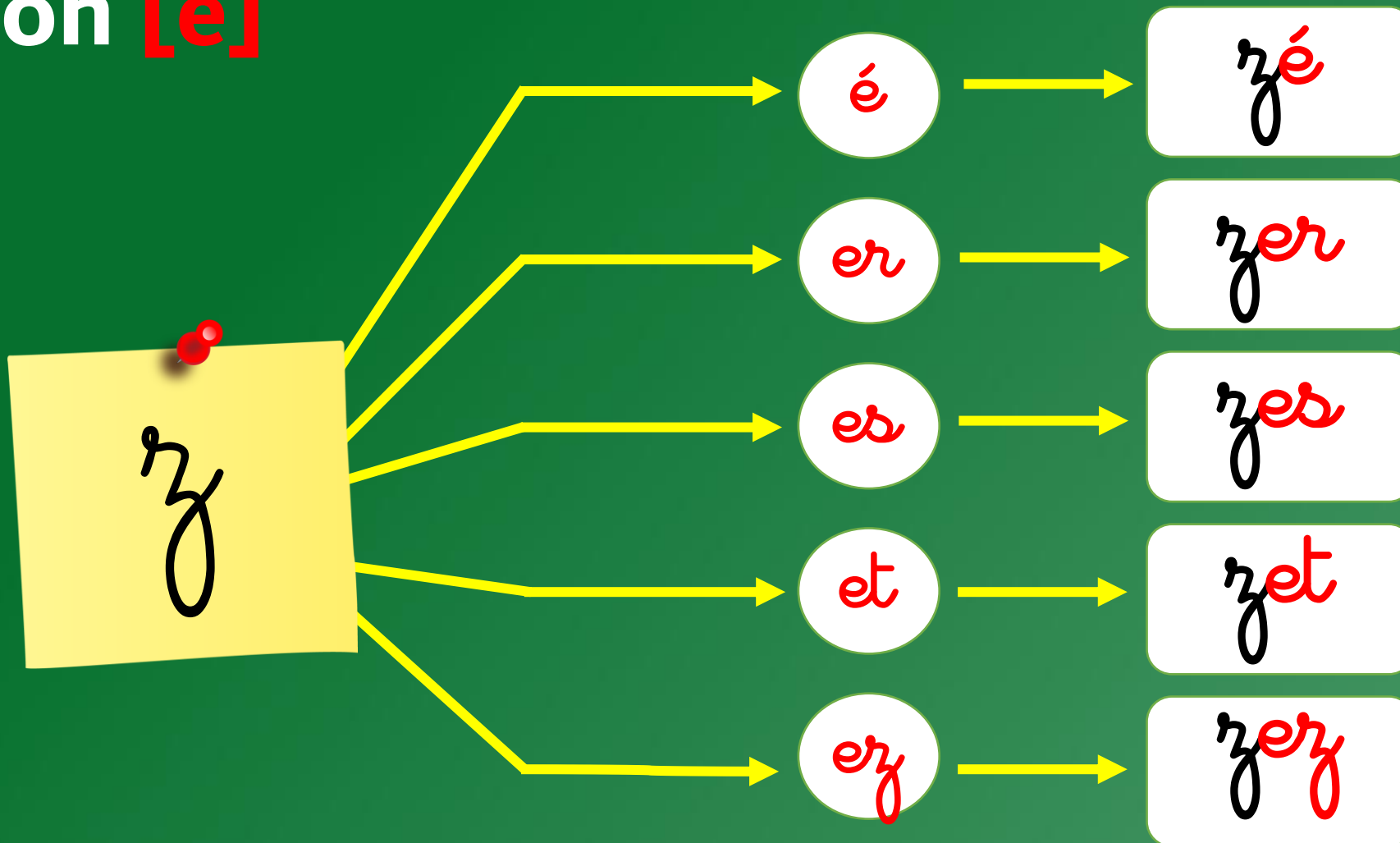

Le son [u]

b ou → bou

c ou → cou

ch ou → chou

d ou → dou

f ou → fou

g ou → gou

h ou → hou

j ou → jou



Le son [u]

k ou → kou

l ou → lou

m ou → mou

n ou → nou

p ou → pou

q ou → quou

r ou → rou

s ou → sou



Le son [u]

t ou → tou

re ou → rou

we ou → wou

œ ou → œou

z ou → zou

qu ou → quou

ph ou → phou



Le son [u]



une toupie

une toupie

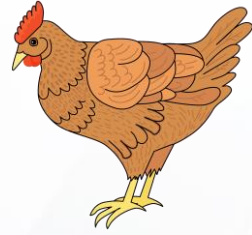

une poule

une poule



un ours

un ours



un hibou

un hibou



un chou

un chou



une poupée

une poupée



un caillou

un caillou



un genou

un genou



des bijoux

des bijoux



un clou

un clou

Le son [ɛ]

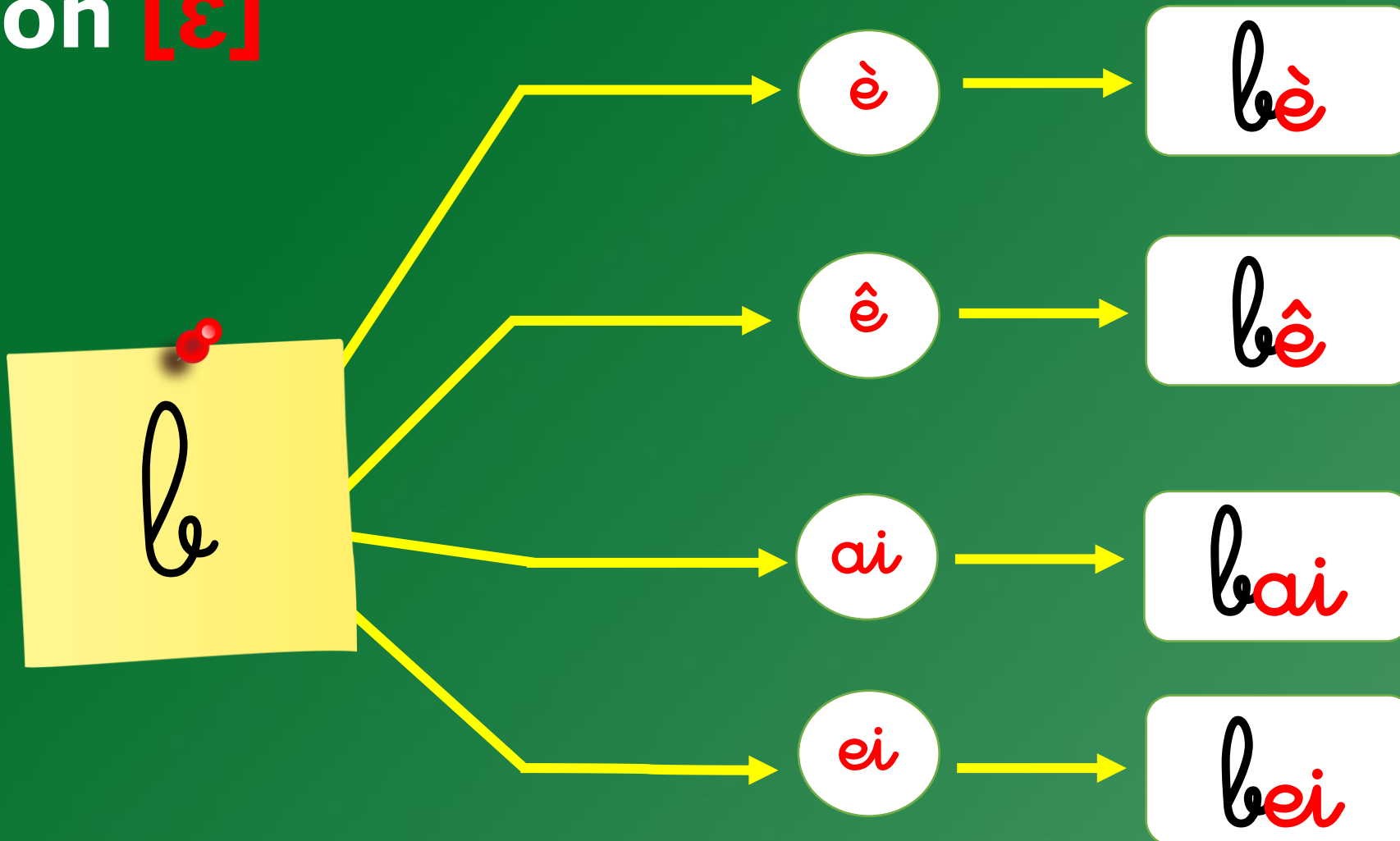

Le son [ɛ]

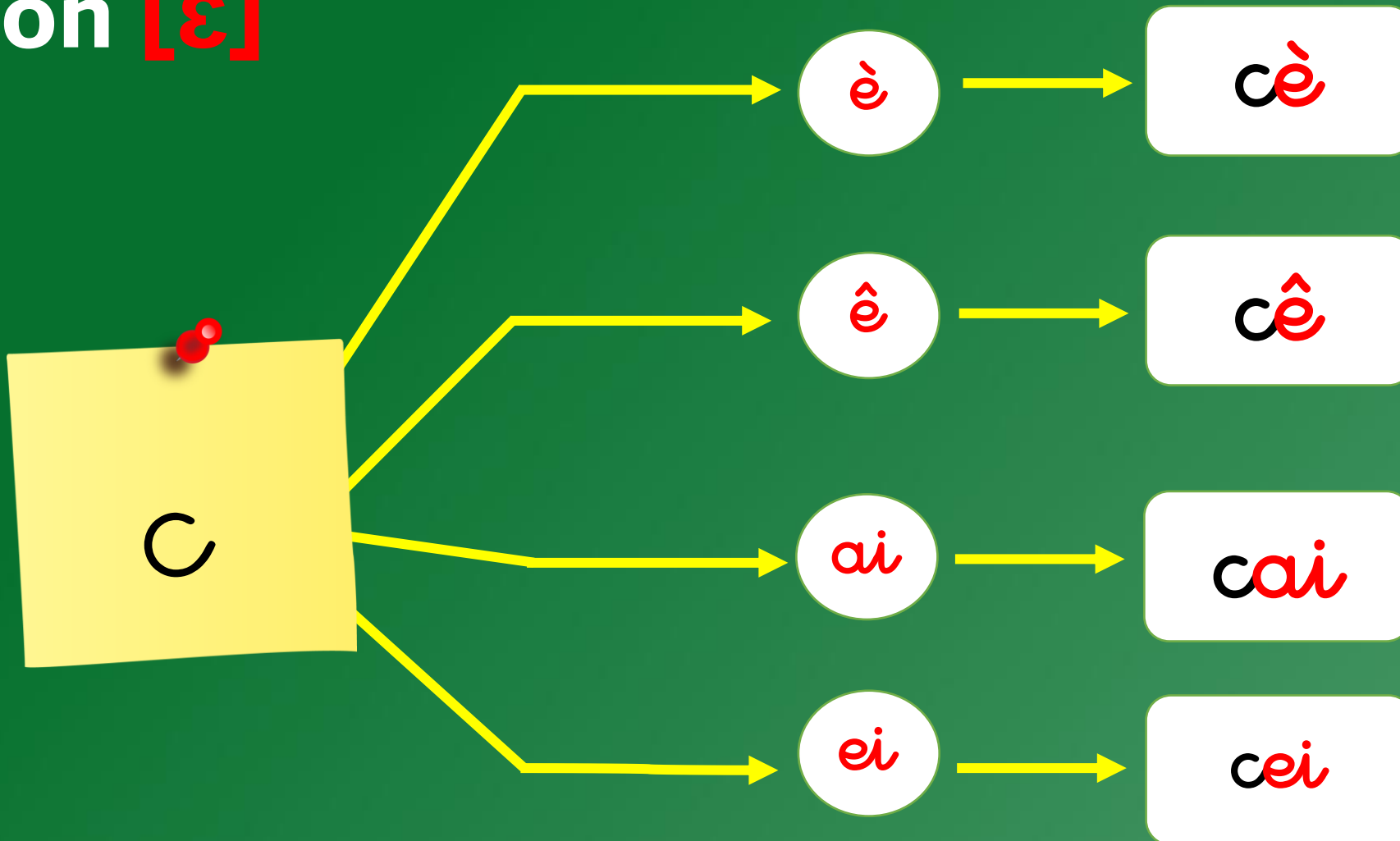

Le son [ɛ]

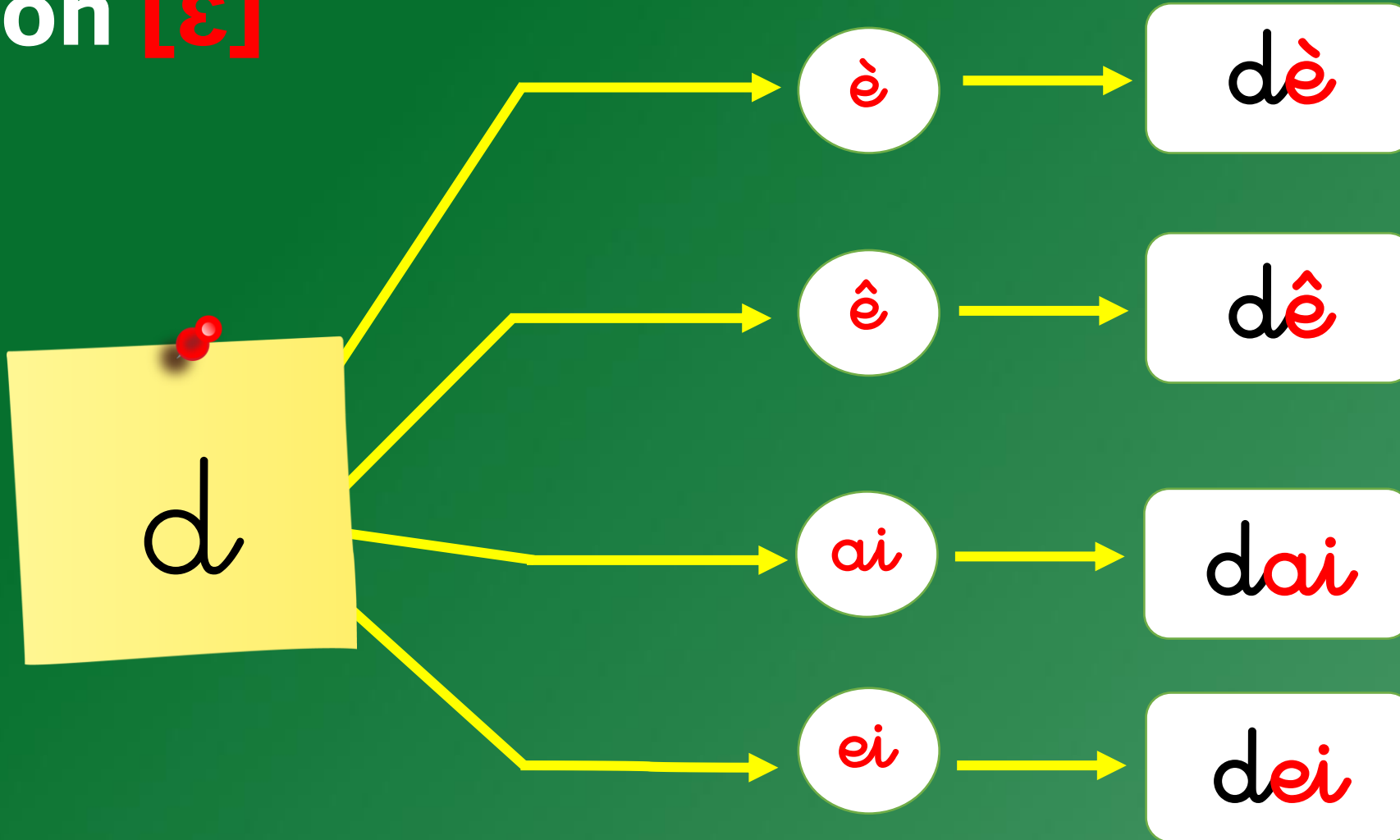

Le son [ɛ]

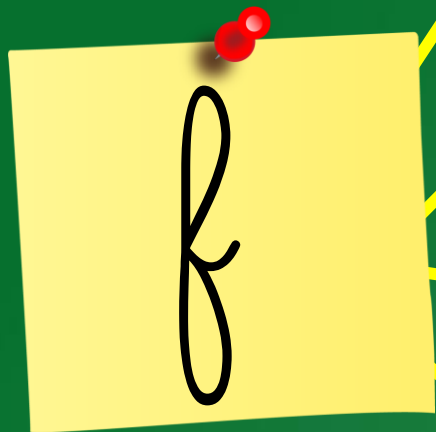

è

fè

ê

fê

ai

fai

ei

fei

قناة المدرس المغربي



Le son [ɛ]

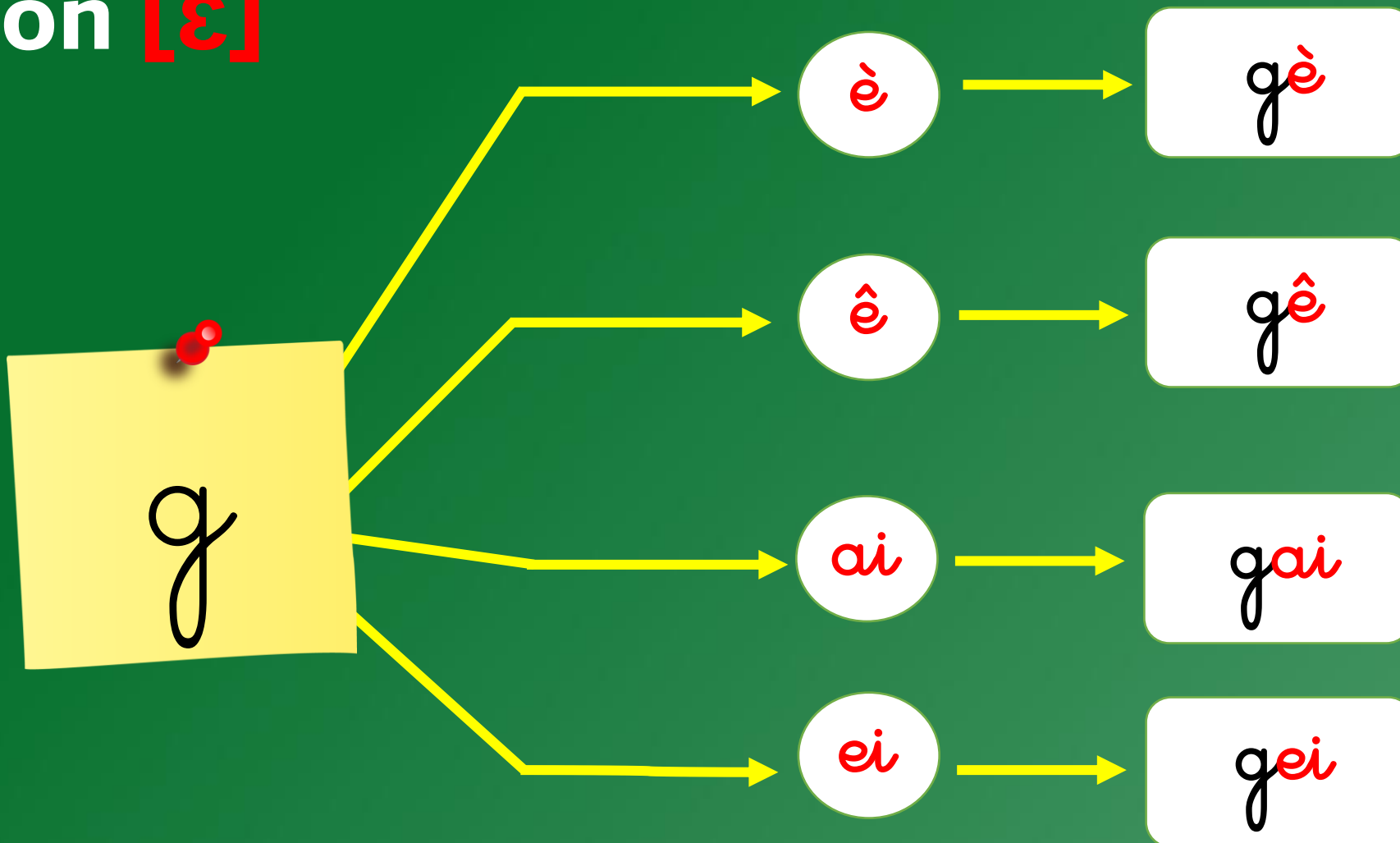

Le son [ɛ]

h

è

hè

ê

hê

ai

hai

ei

hei

قناة المدرس المغربي



Le son [ɛ]

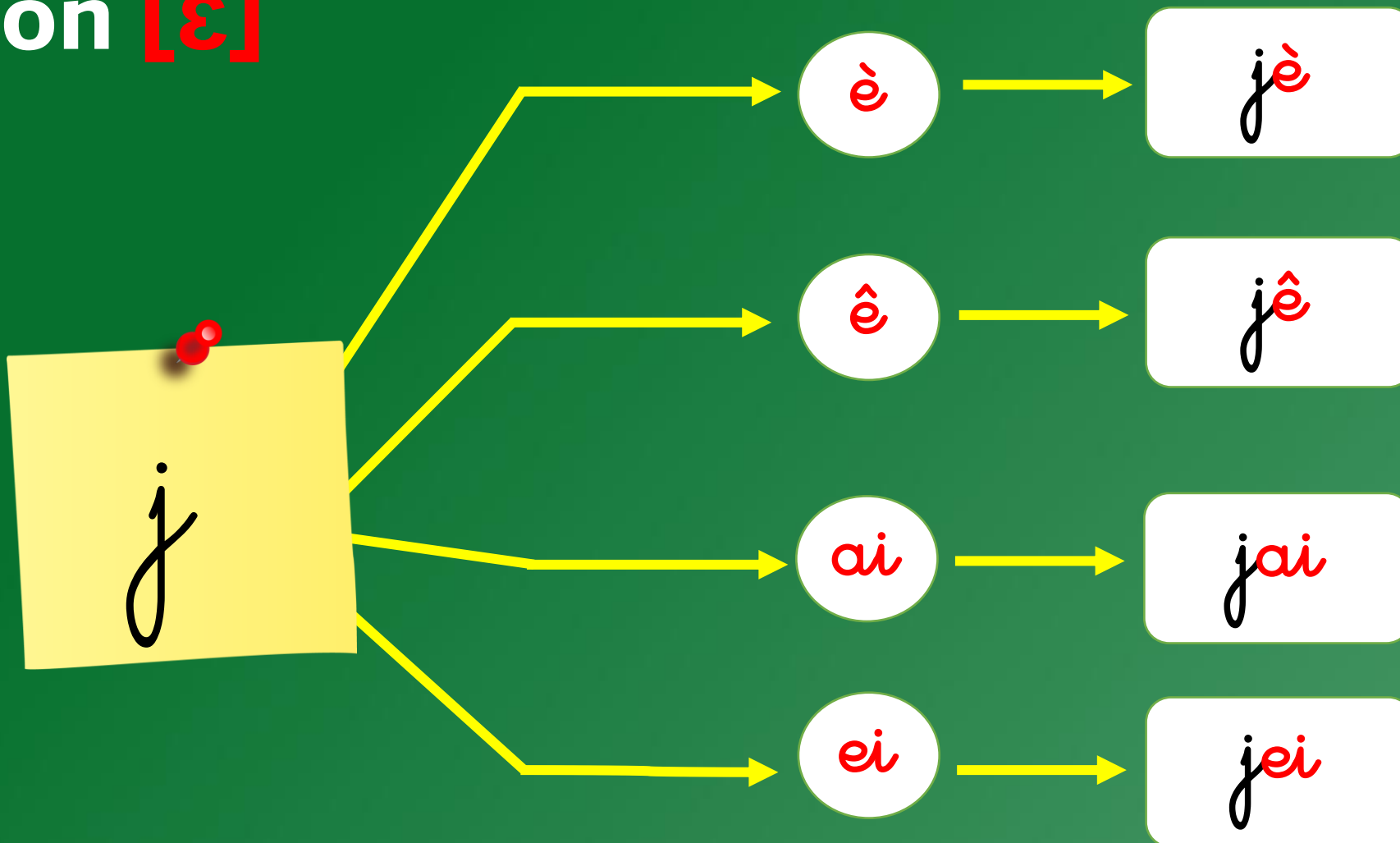

Le son [ε]

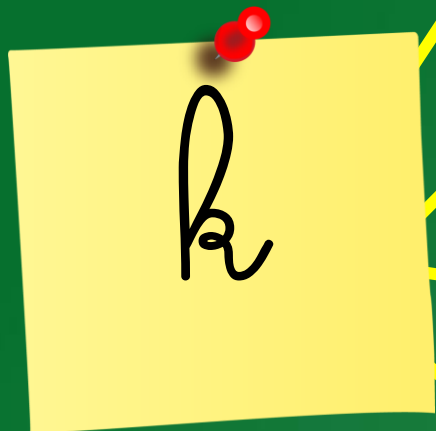

è

kè

ê

kê

ai

kai

ei

kei

قناة المدرس المغربي



Le son [ɛ]

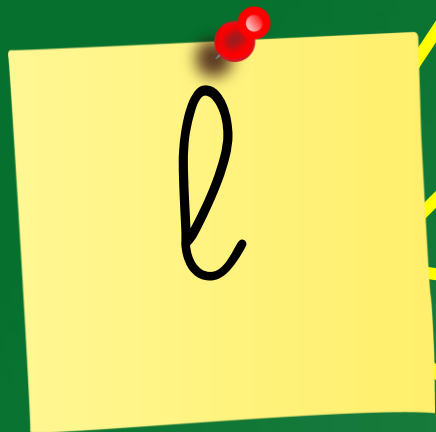

è

lè

ê

lê

ai

lai

ei

lei

قناة المدرس المغربي



Le son [ɛ]

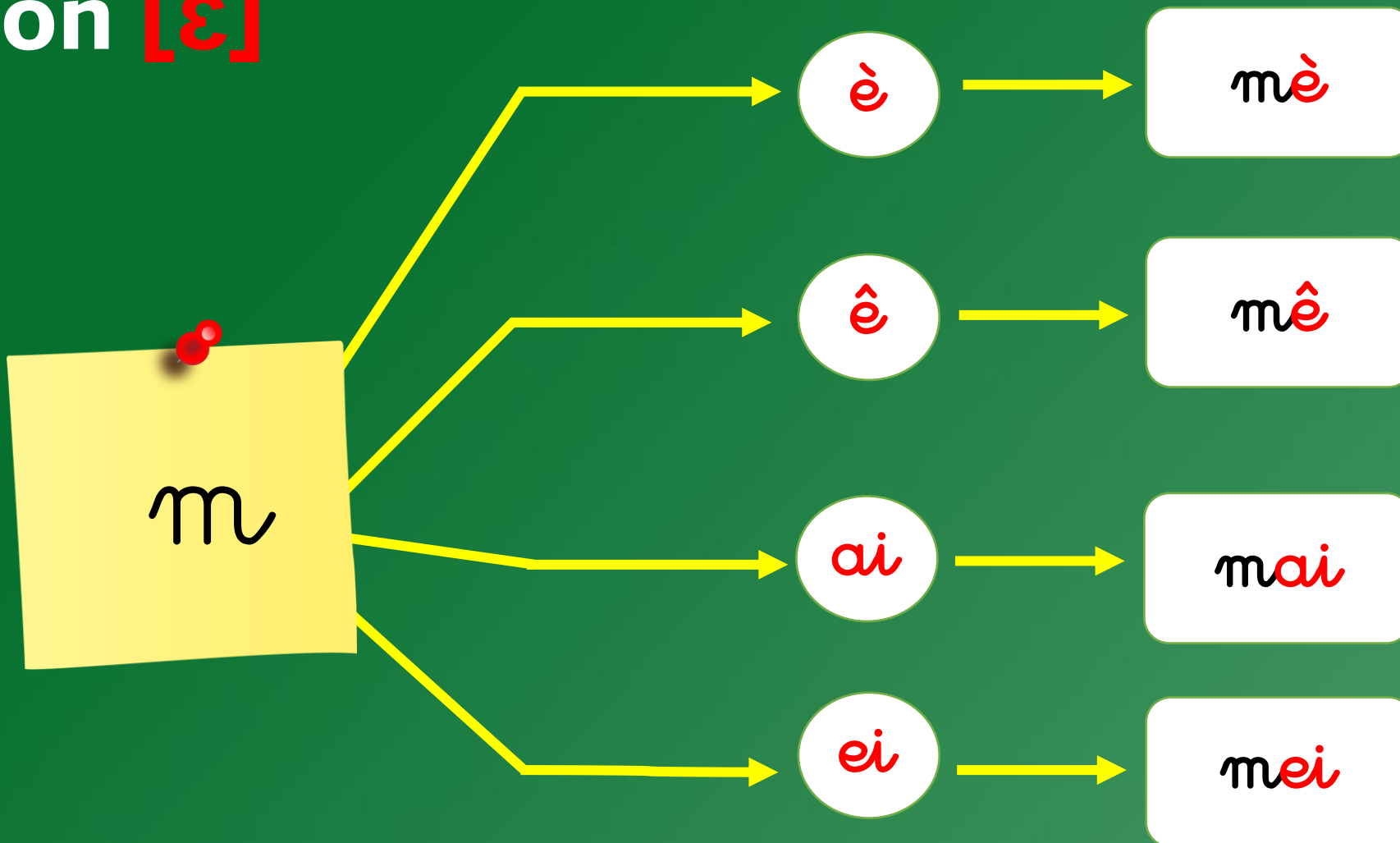

قناة المدرس المغربي



Le son [ɛ]

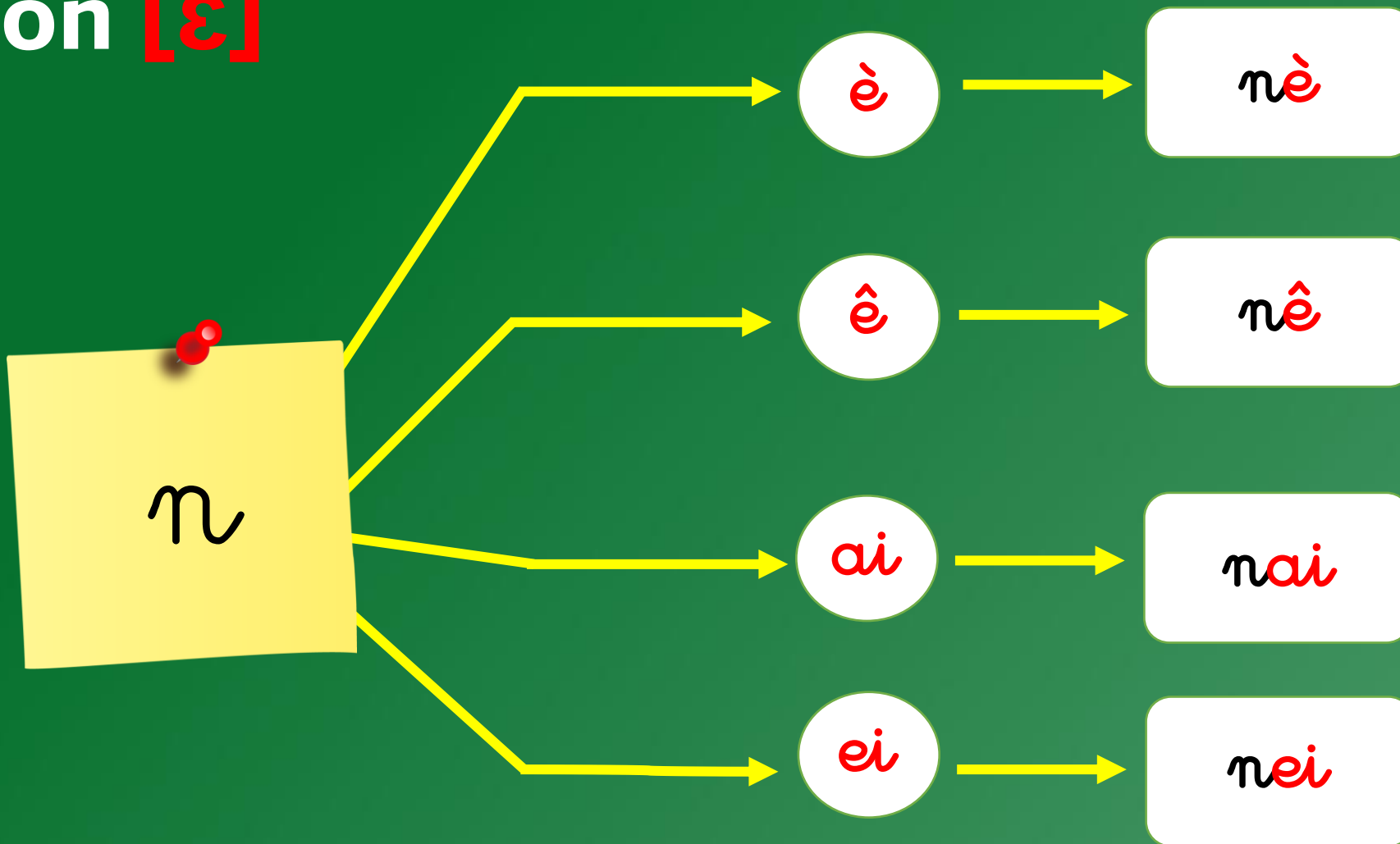

Le son [ɛ]

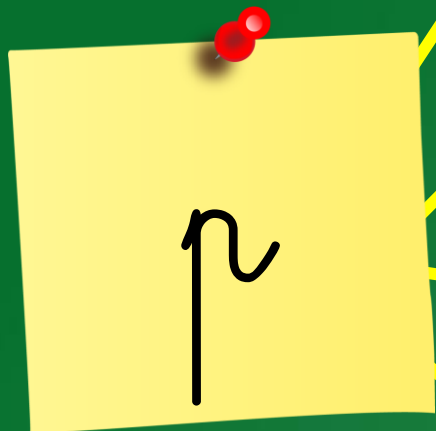

è

pe

ê

pê

ai

pai

ei

pei

قناة المدرس المغربي



Le son [ɛ]

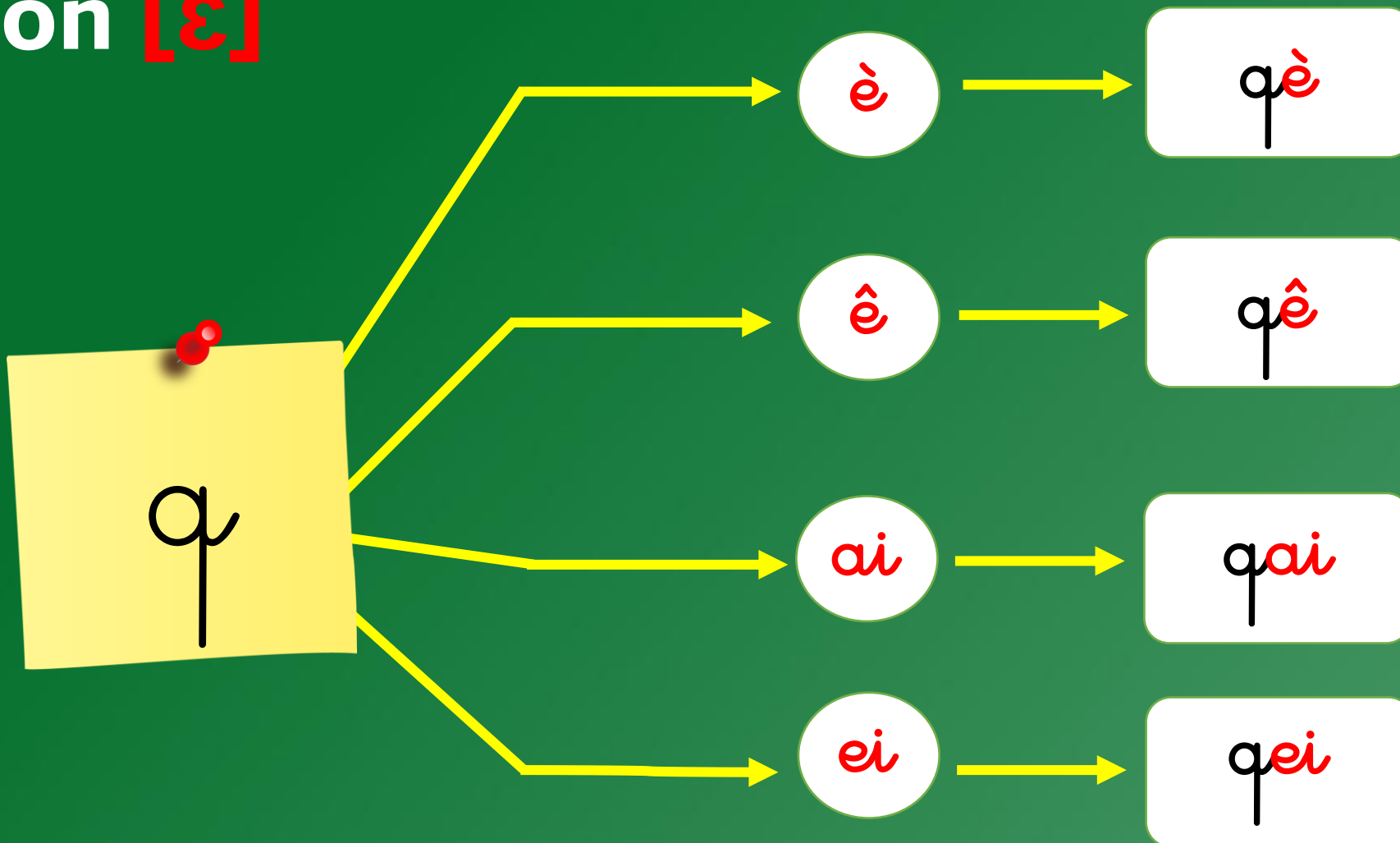

Le son [ɛ]

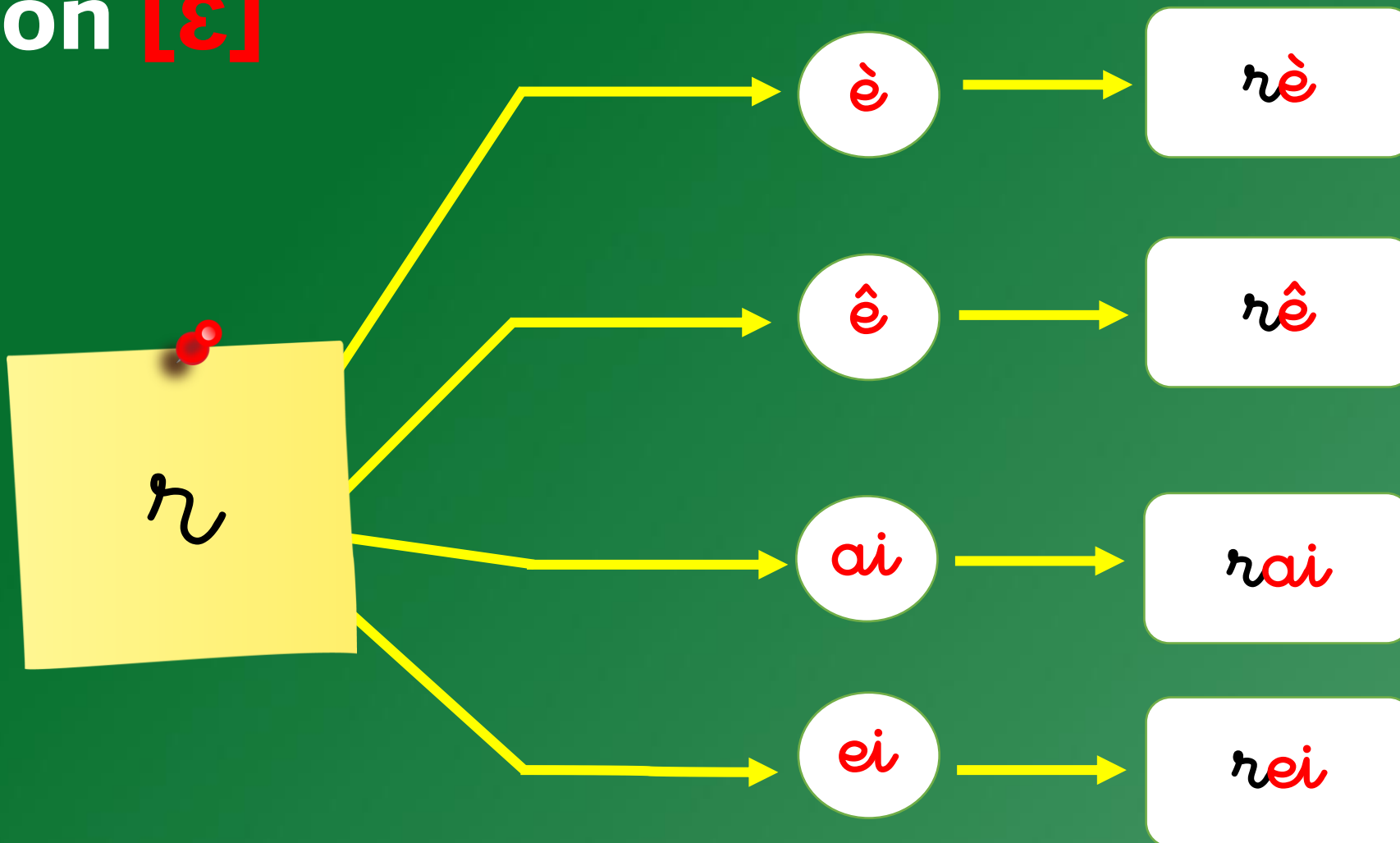

Le son [ɛ]

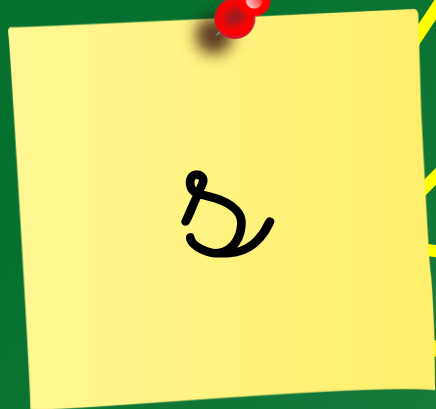

è

عè

ê

عê

ai

عai

ei

عei

قناة المدرس المغربي



Le son [ɛ]

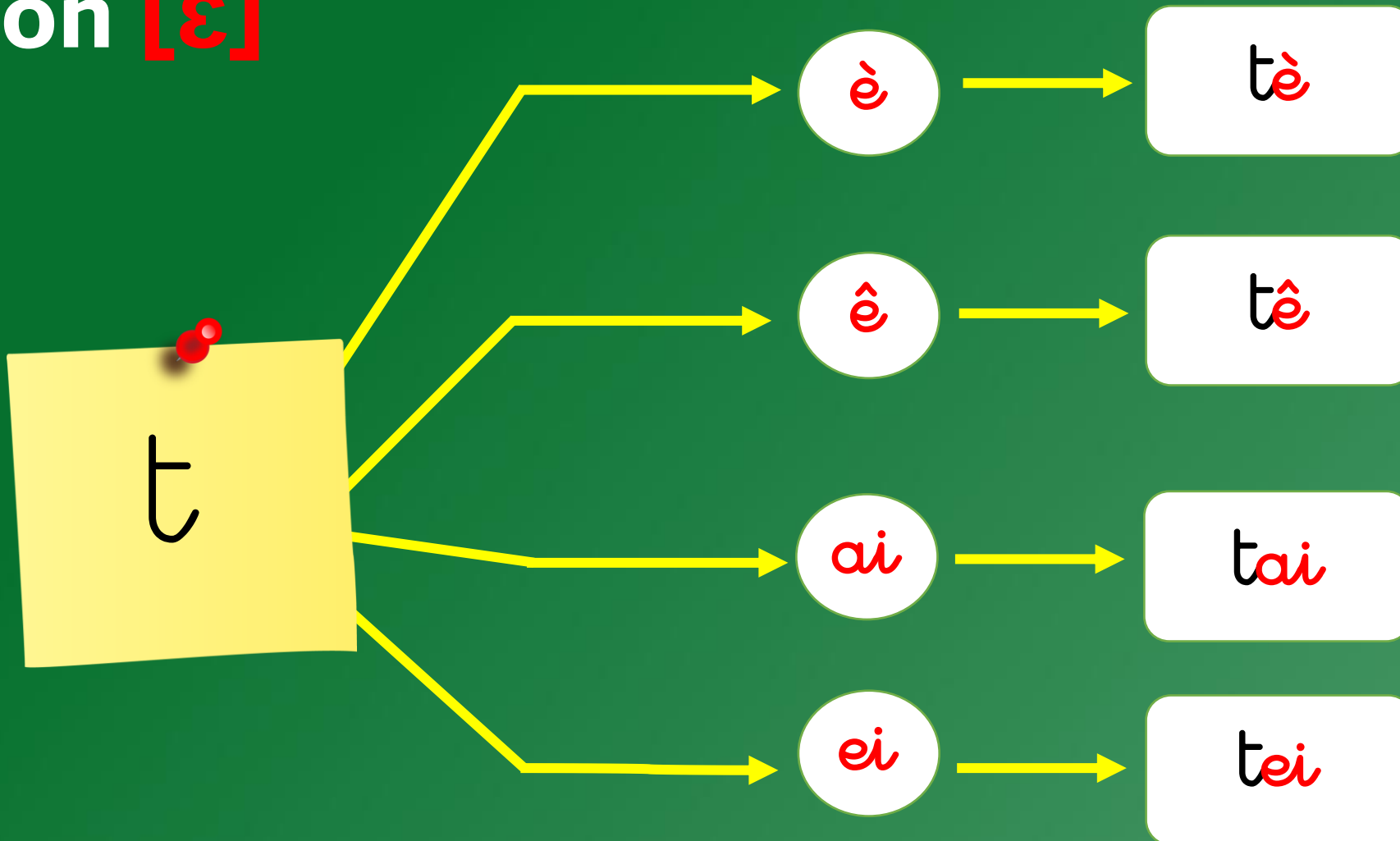

Le son [ɛ]

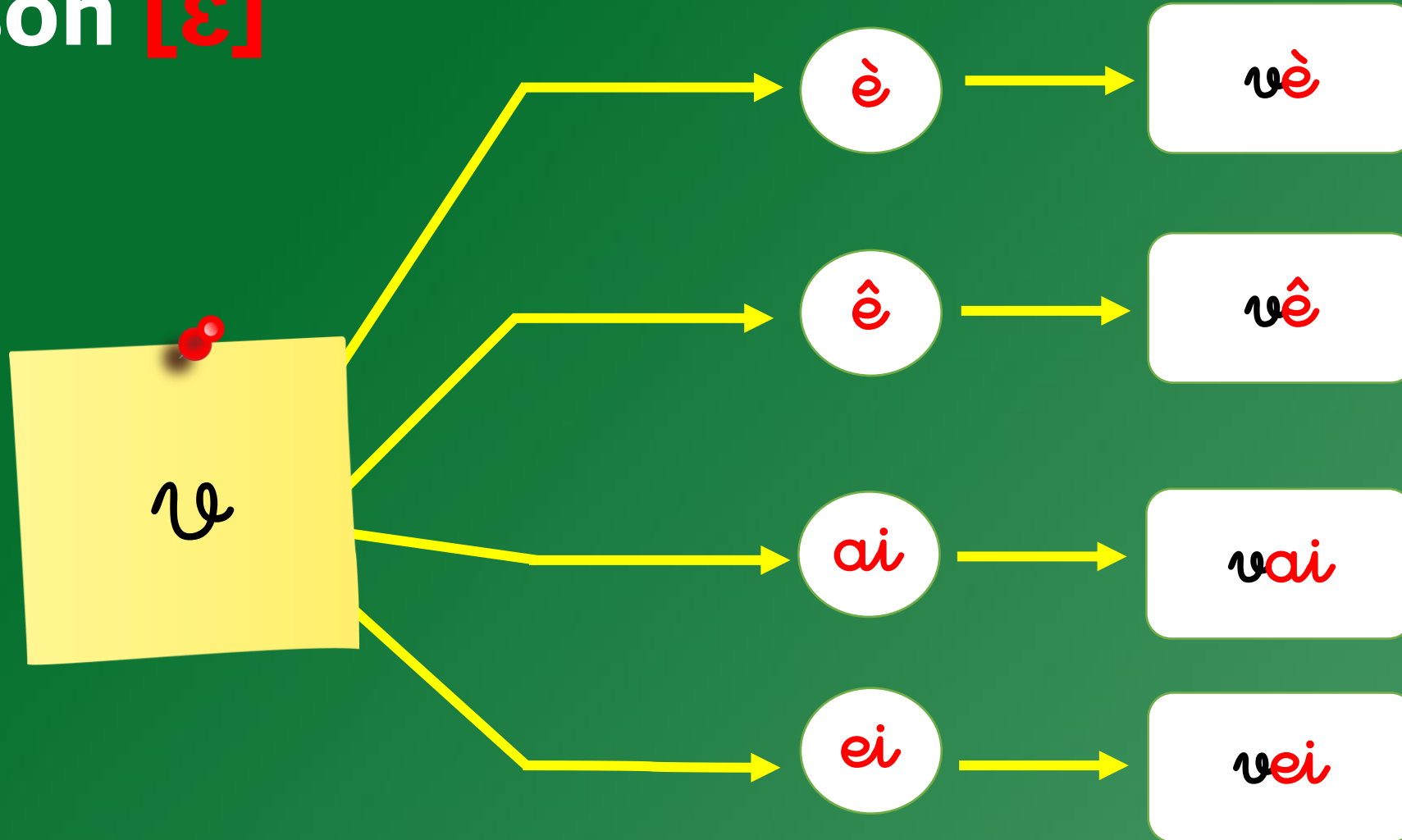

قناة المدرس المغربي



Le son [ɛ]

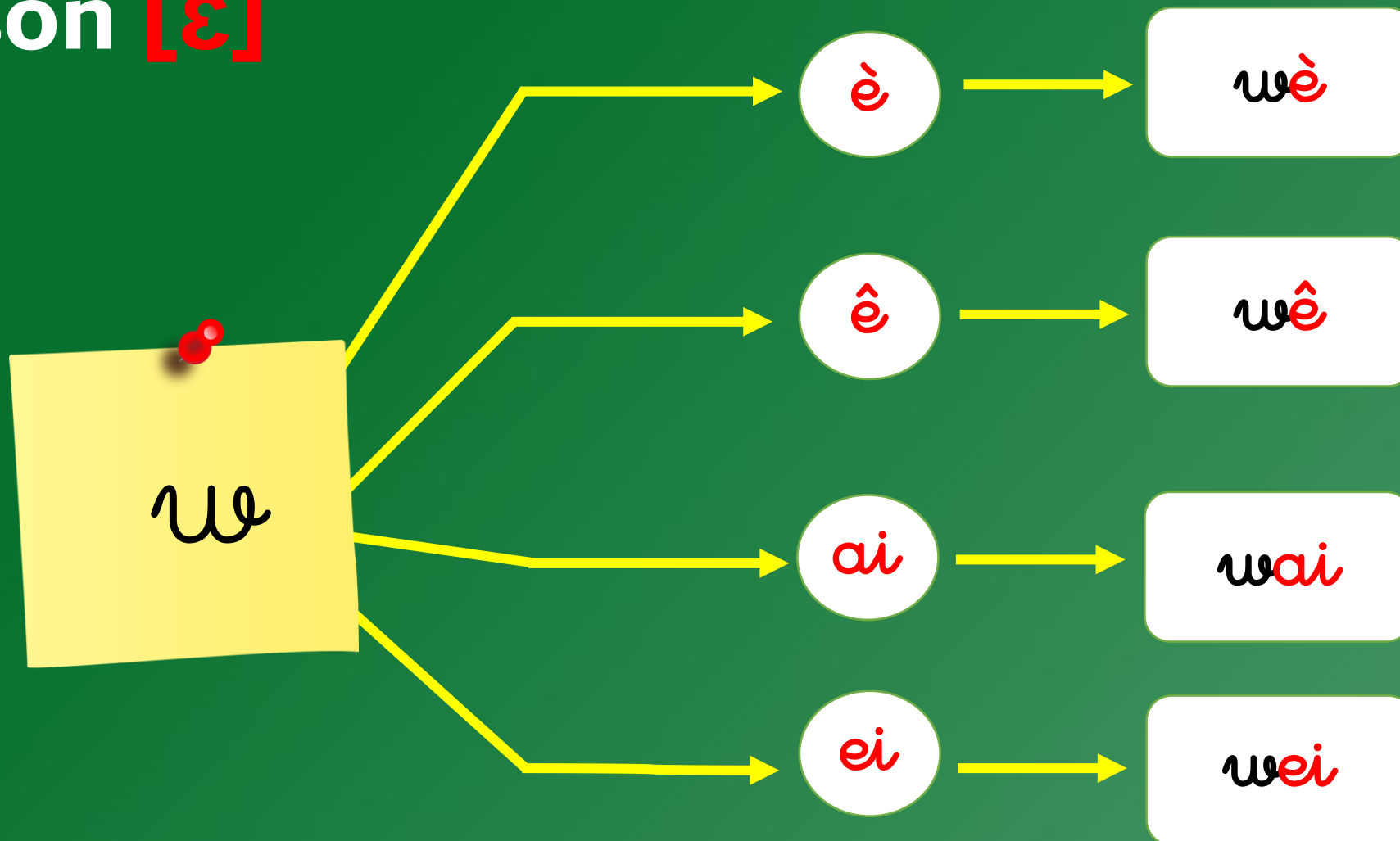

قناة المدرس المغربي



Le son [ɛ]

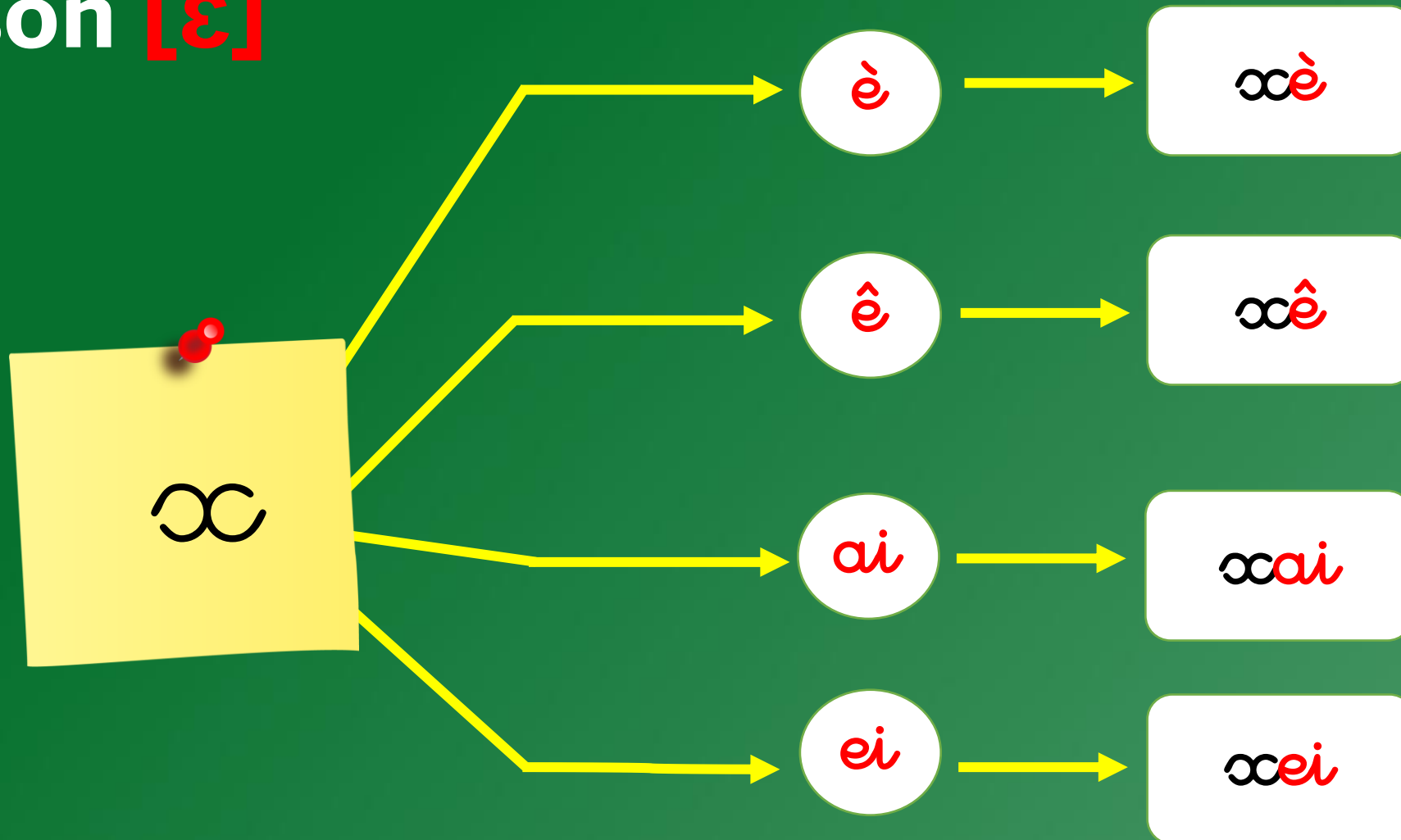

قناة المدرس المغربي



Le son [ɛ]

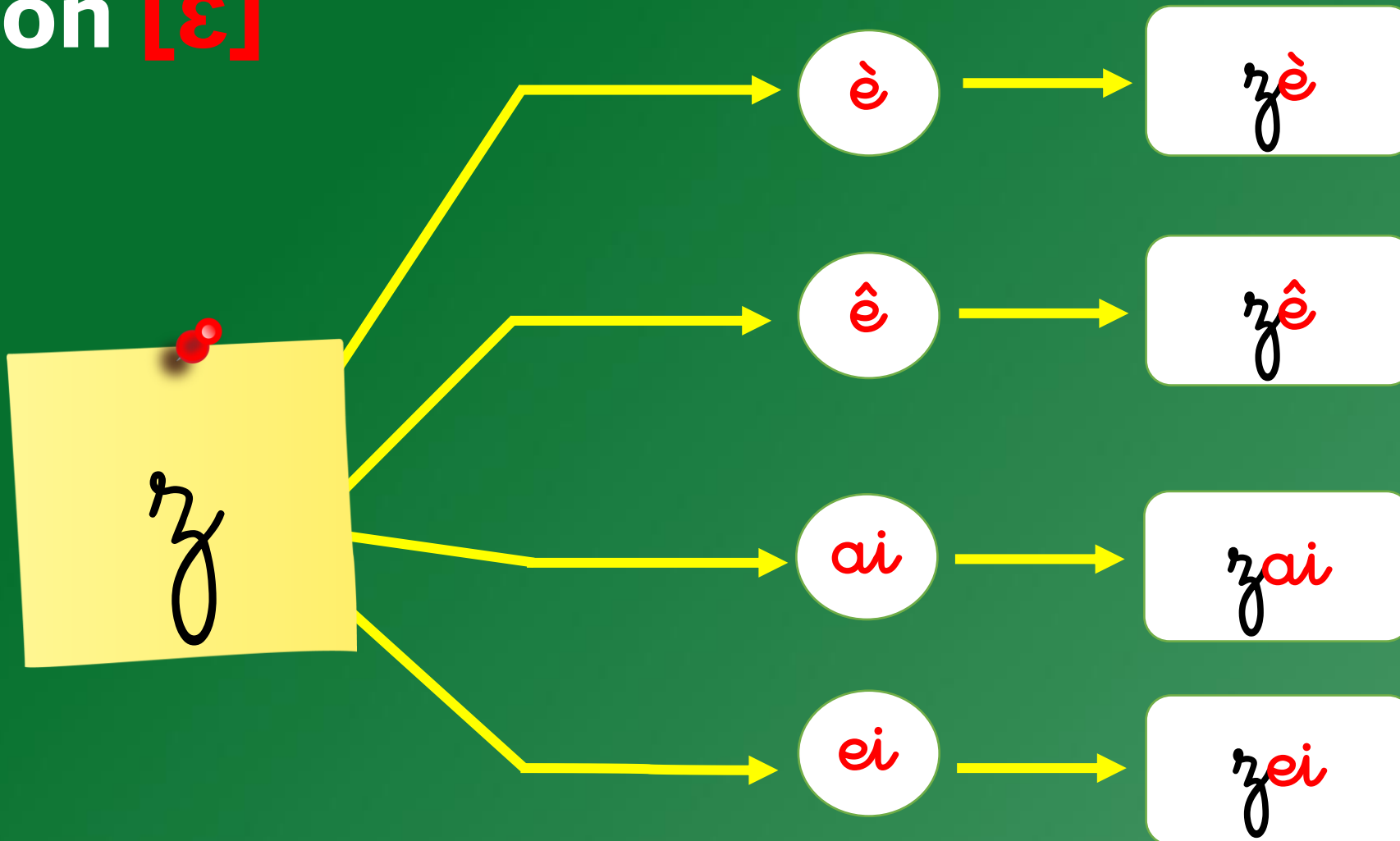

Le son [ɛ]

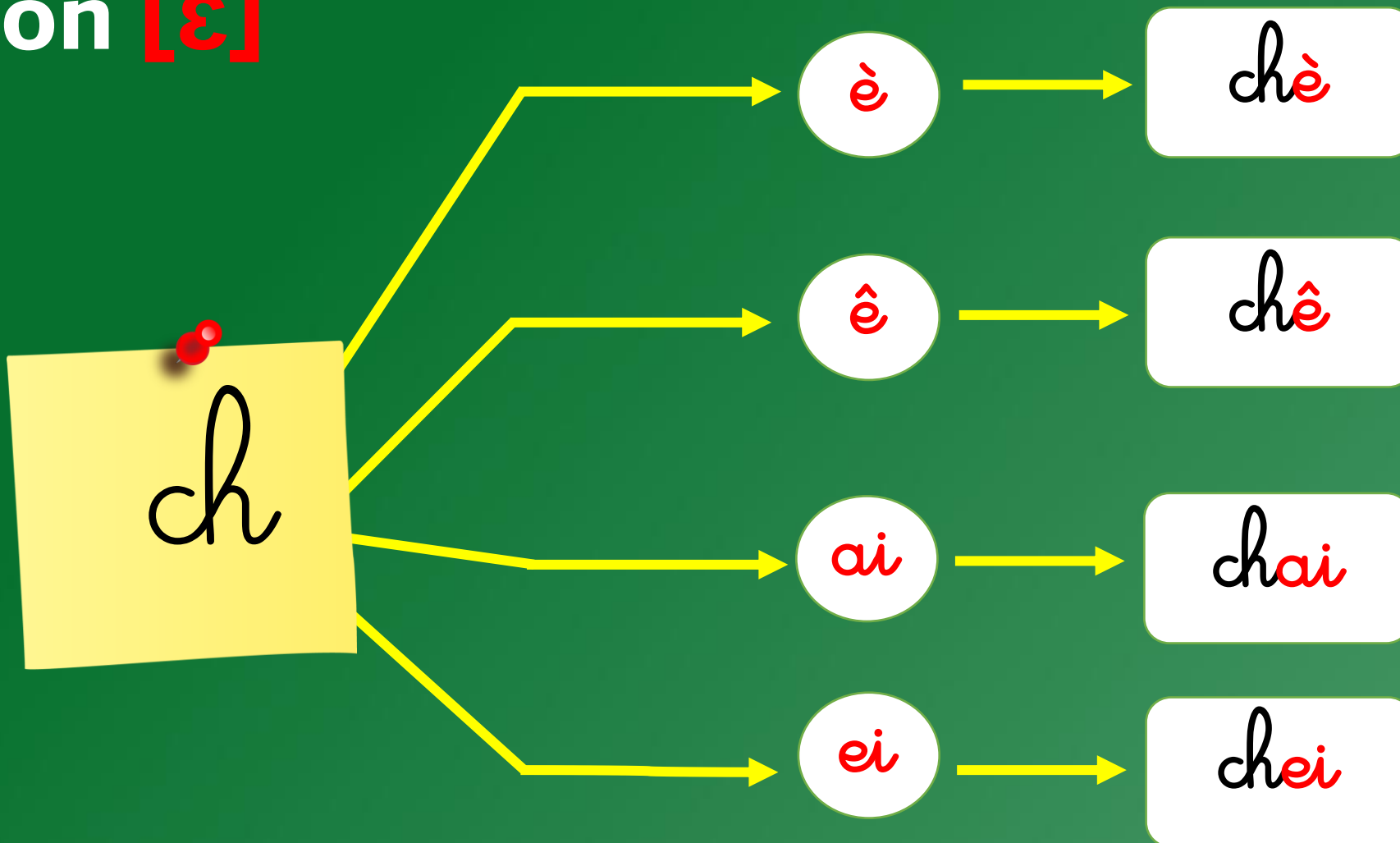

Le son [ɛ]

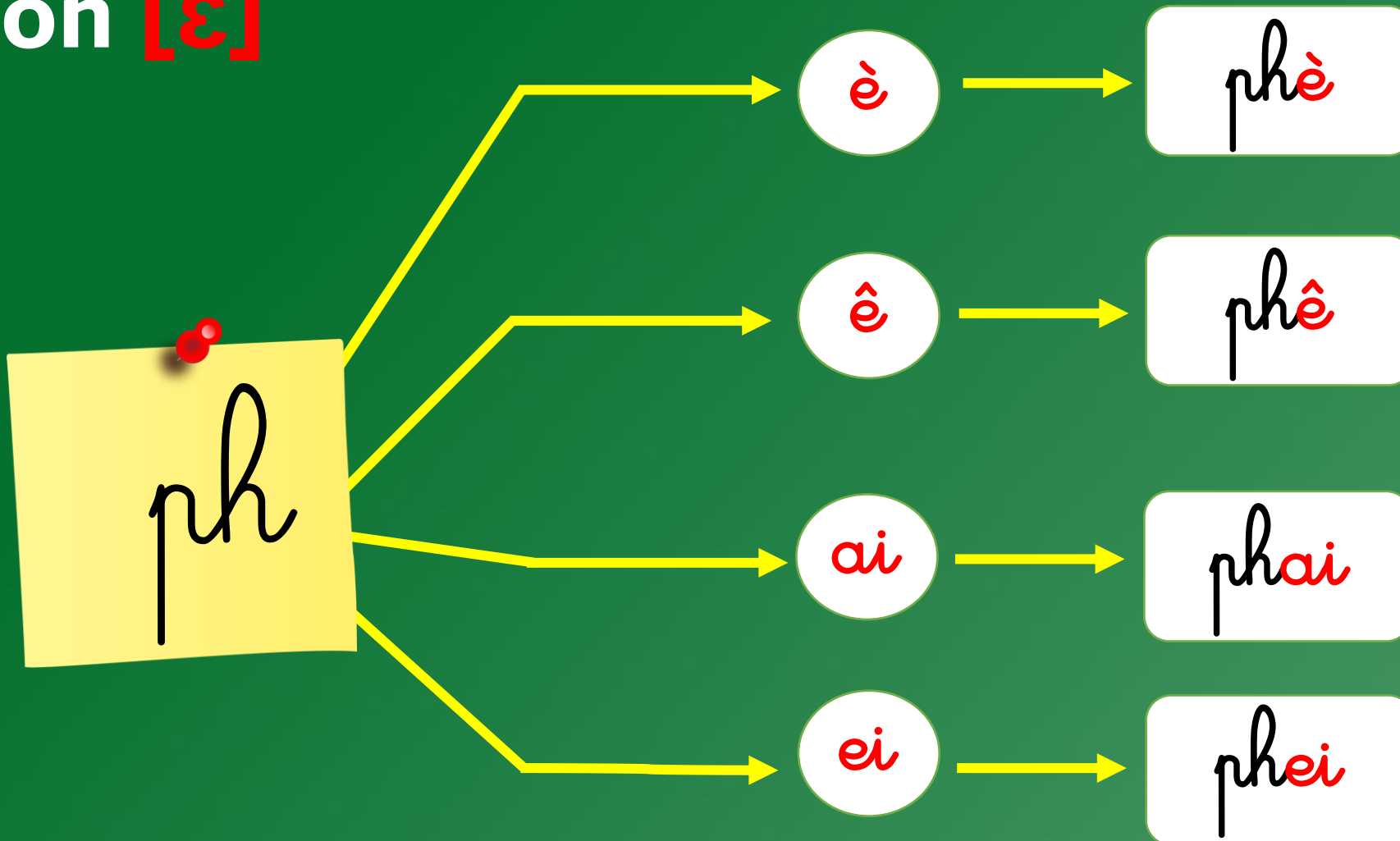

Le son [ɛ]

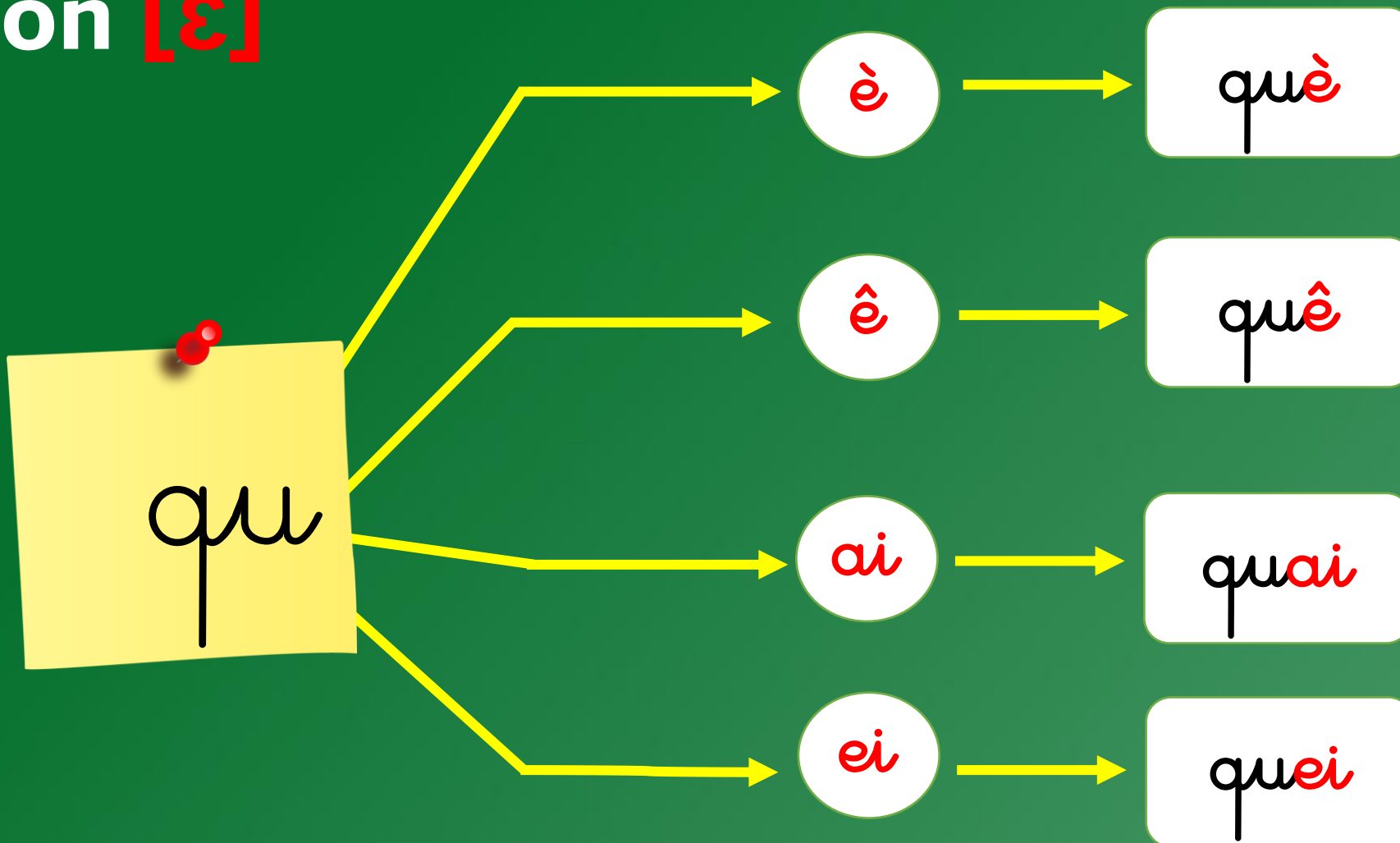

Le son [ɑ]

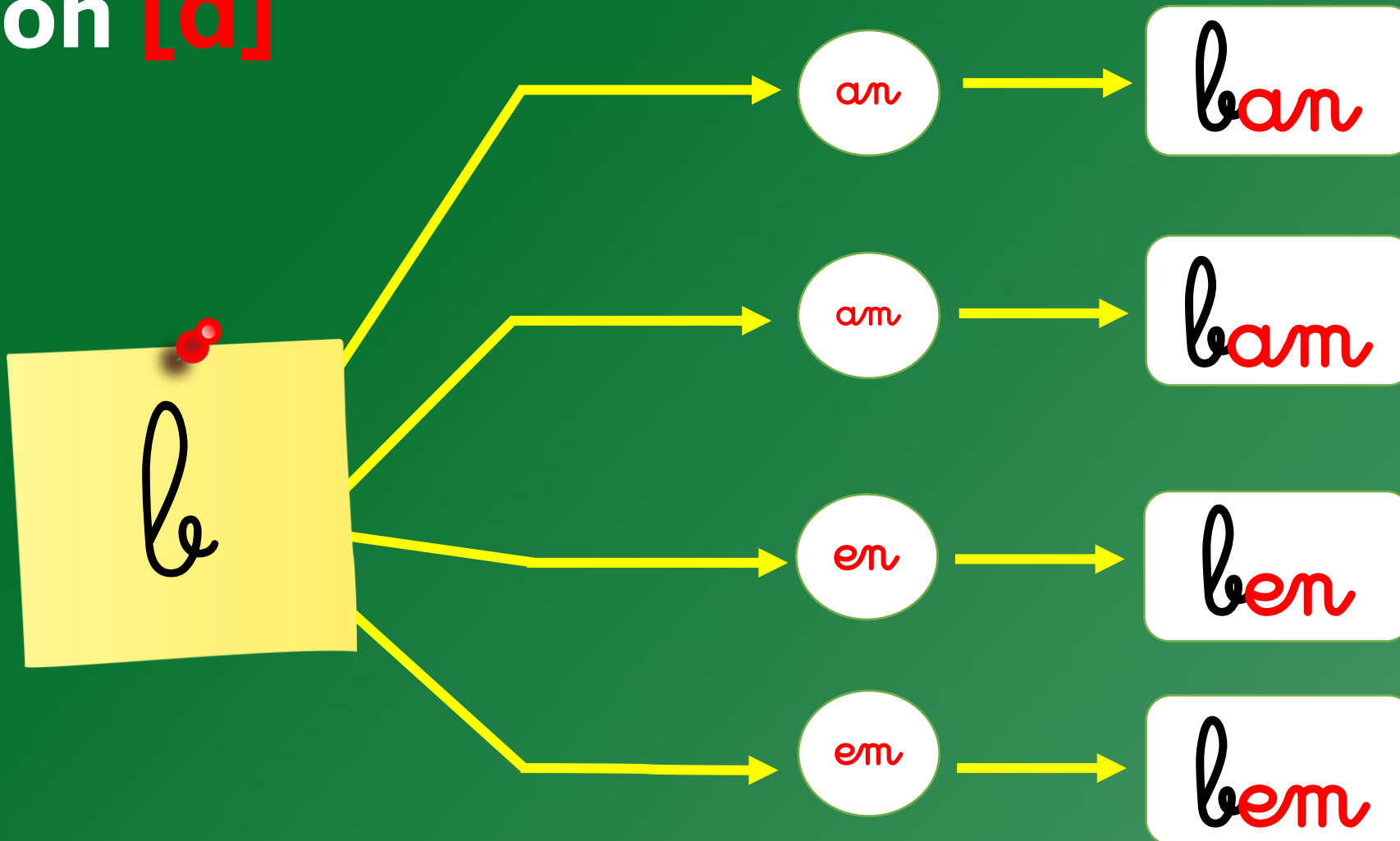

قناة المدرس المغربي



Le son [ɑ]

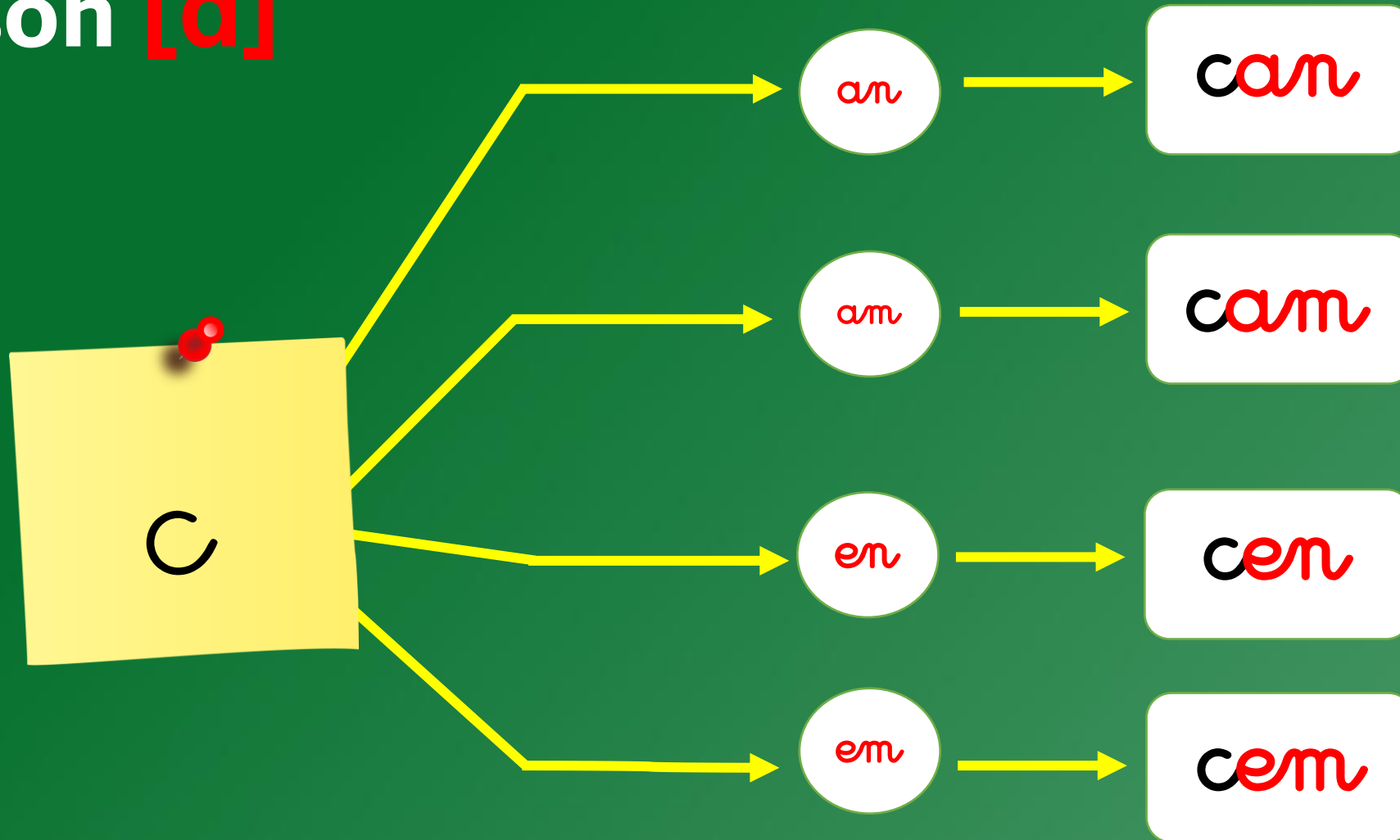

قناة المدرس المغربي



Le son [ɑ]

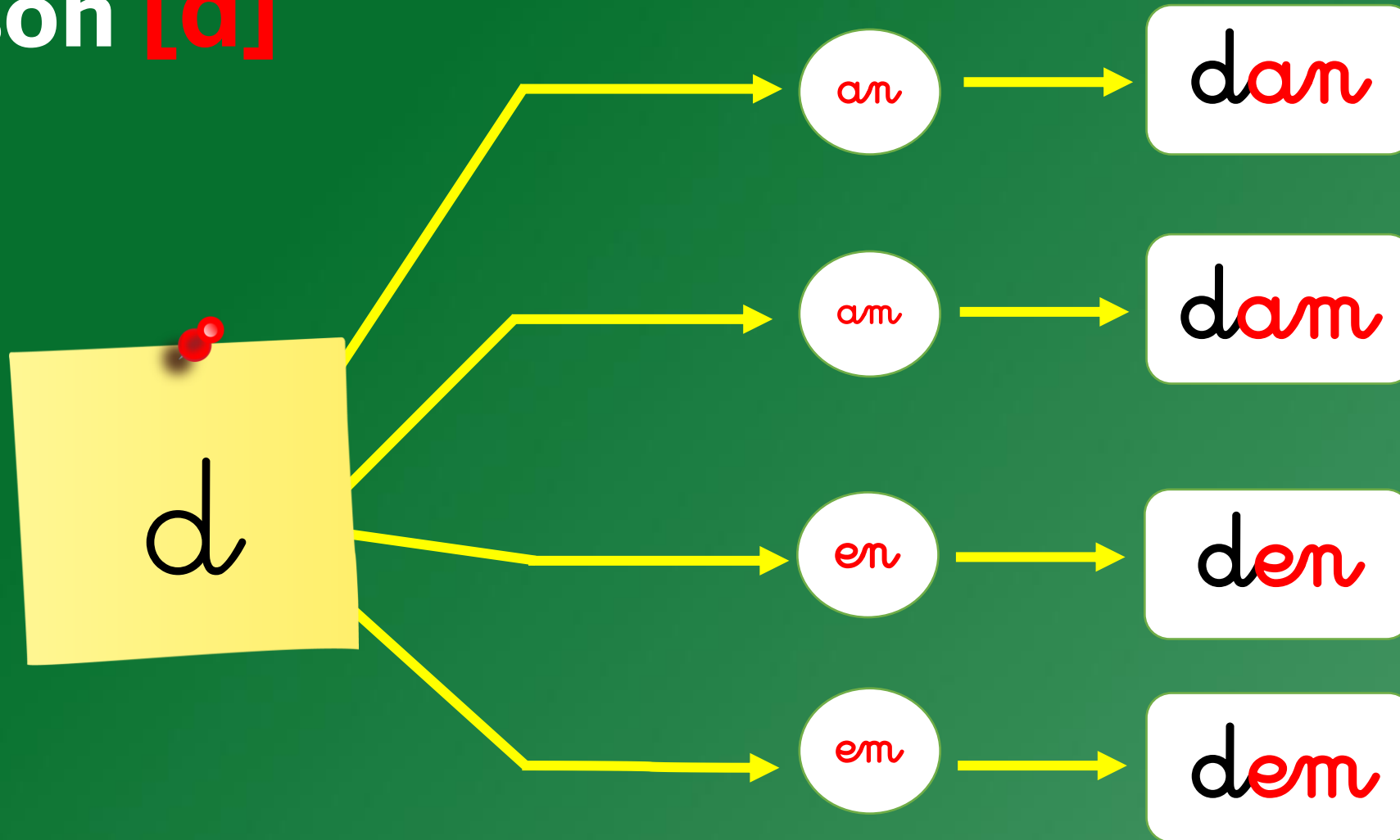

Le son [ɑ]

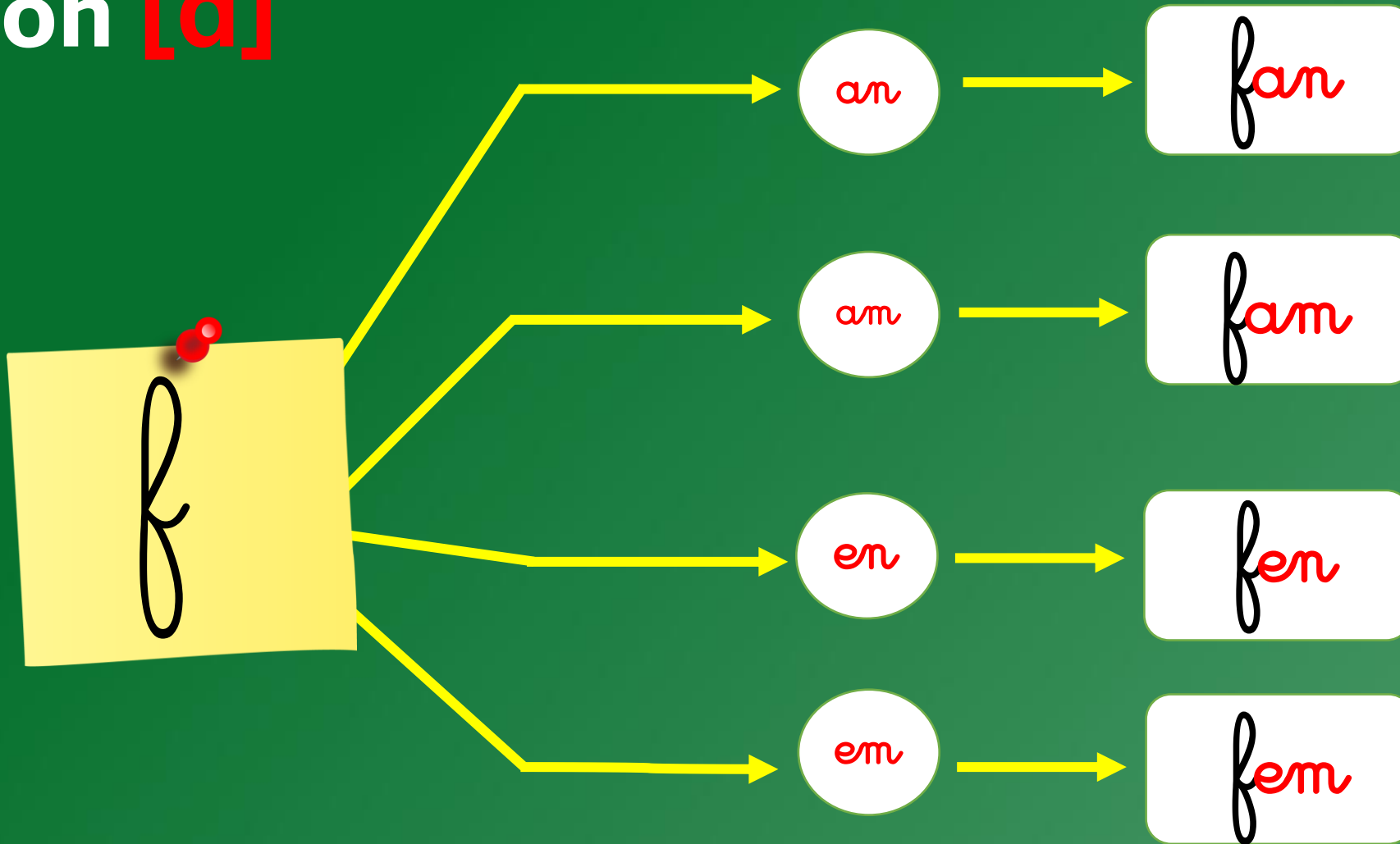

قناة المدرس المغربي



Le son [ɑ]

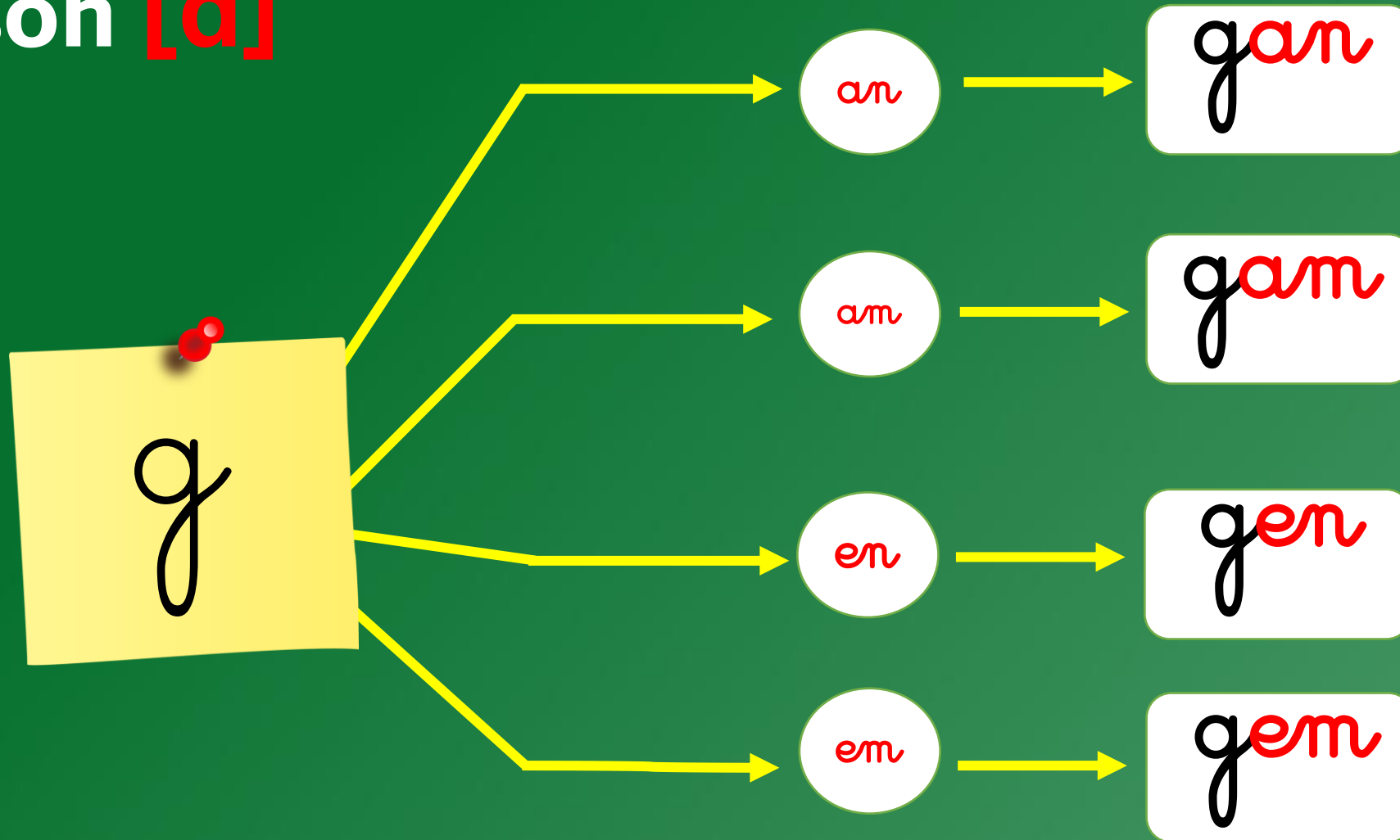

Le son [ɑ]

h

an

han

am

ham

en

hen

em

hem

قناة المدرس المغربي



Le son [ɑ]

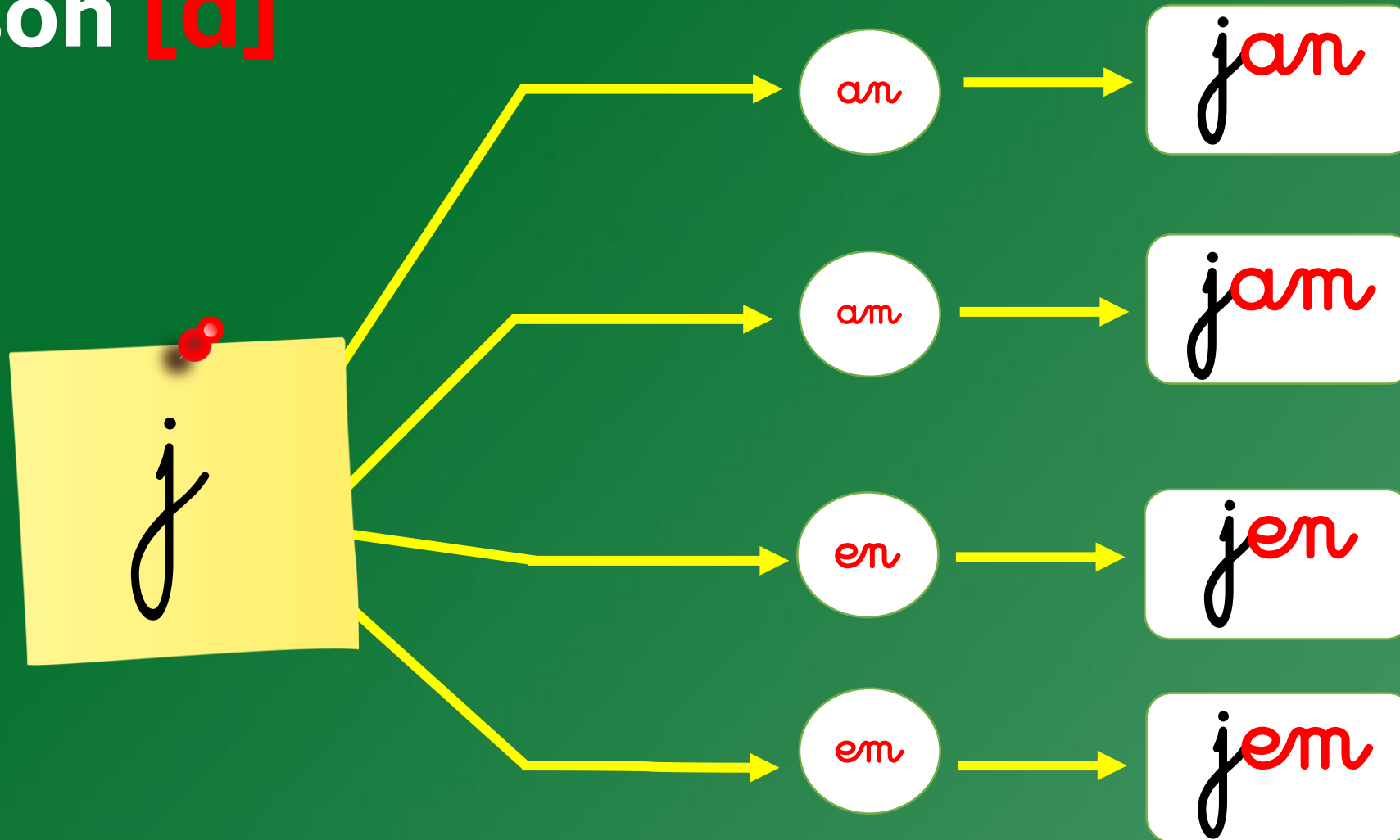

Le son [ɑ]

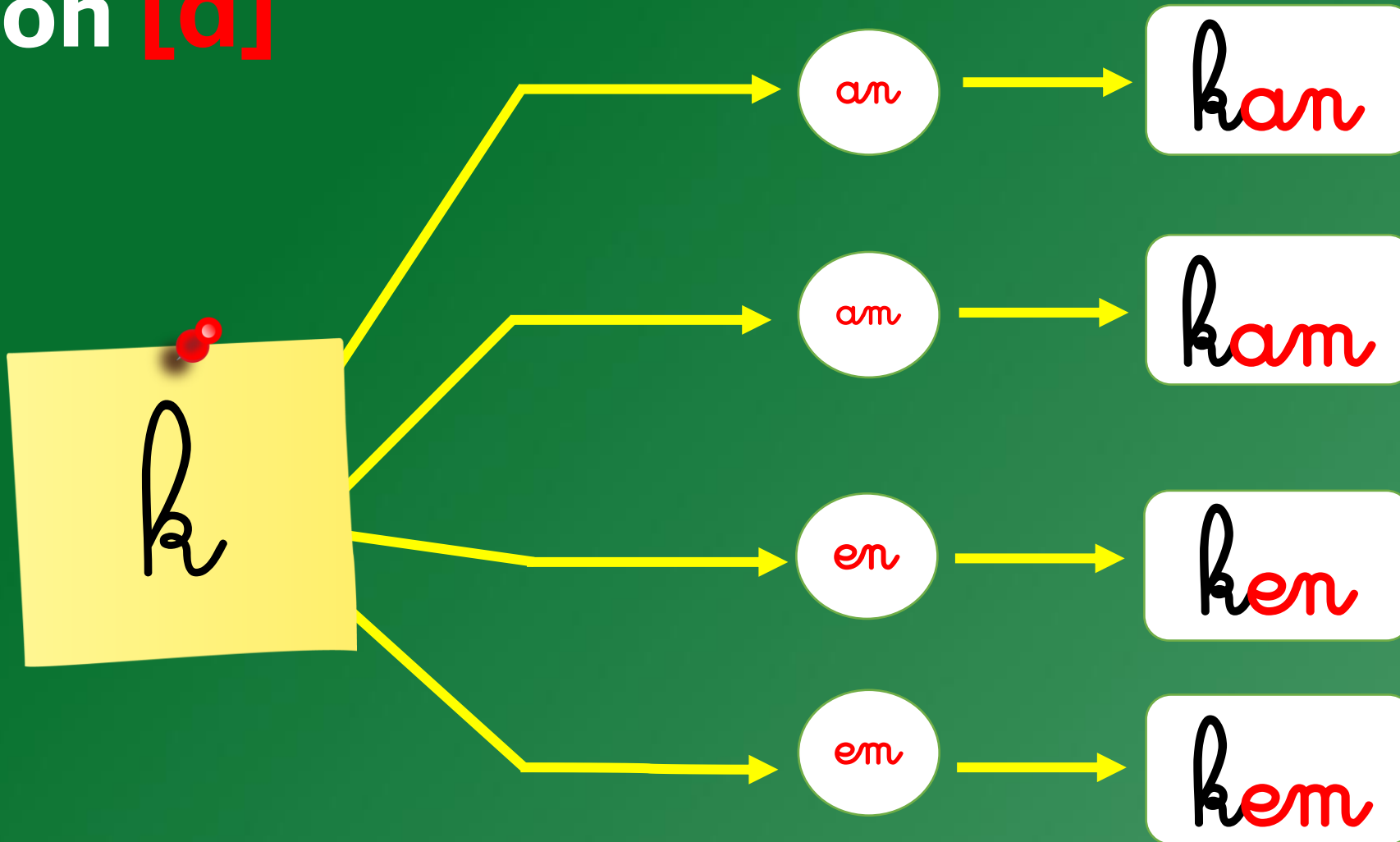

Le son [ɑ]

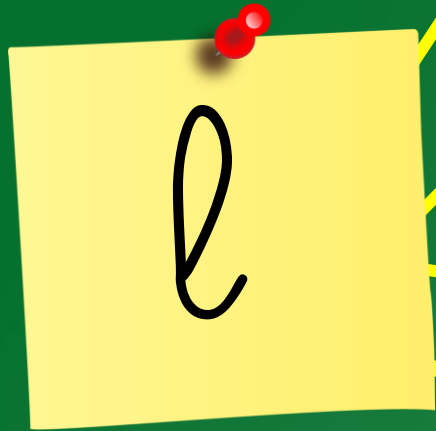

an

lan

am

lam

en

len

em

lem



Le son [ɑ]

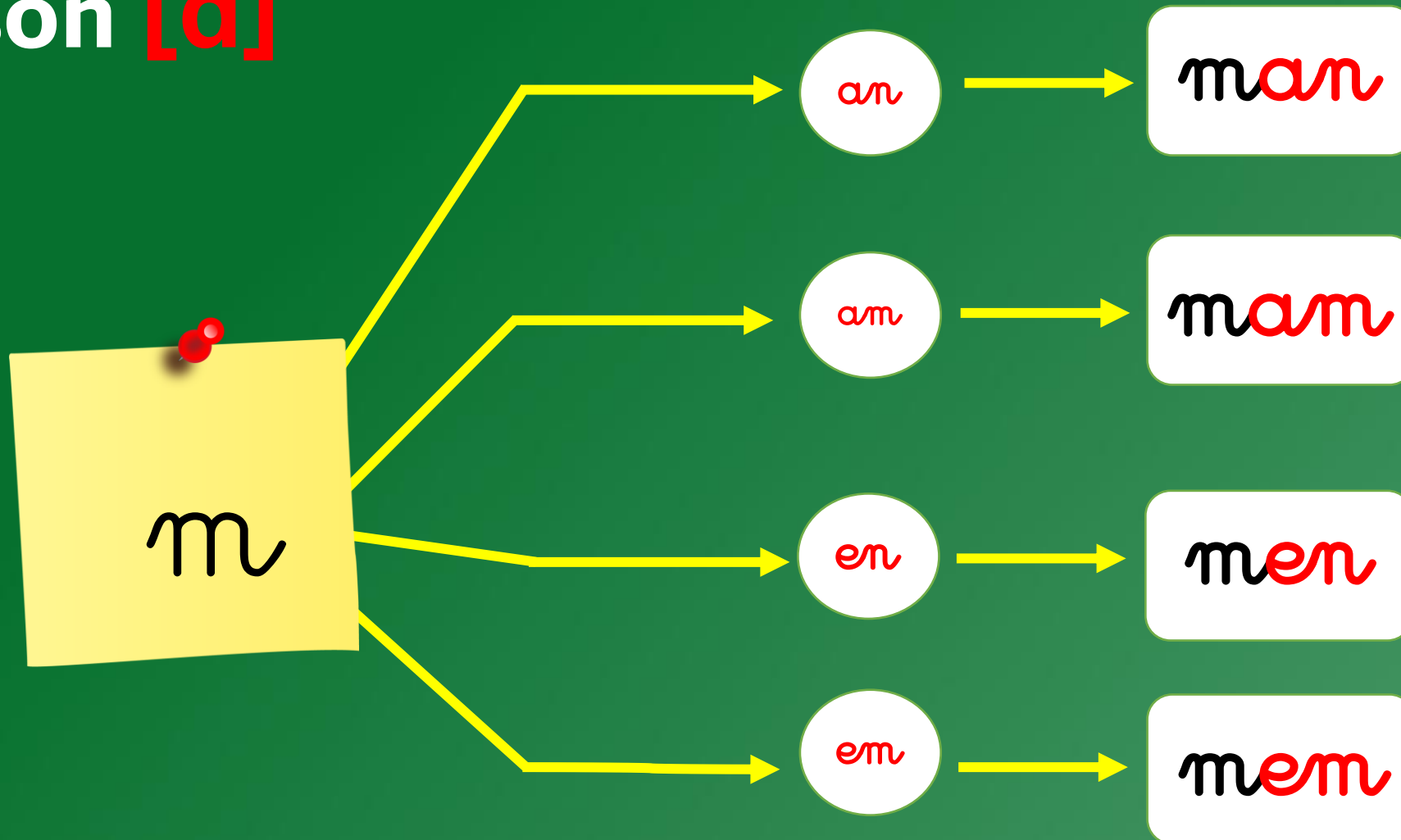

قناة المدرس المغربي



Le son [ɑ]

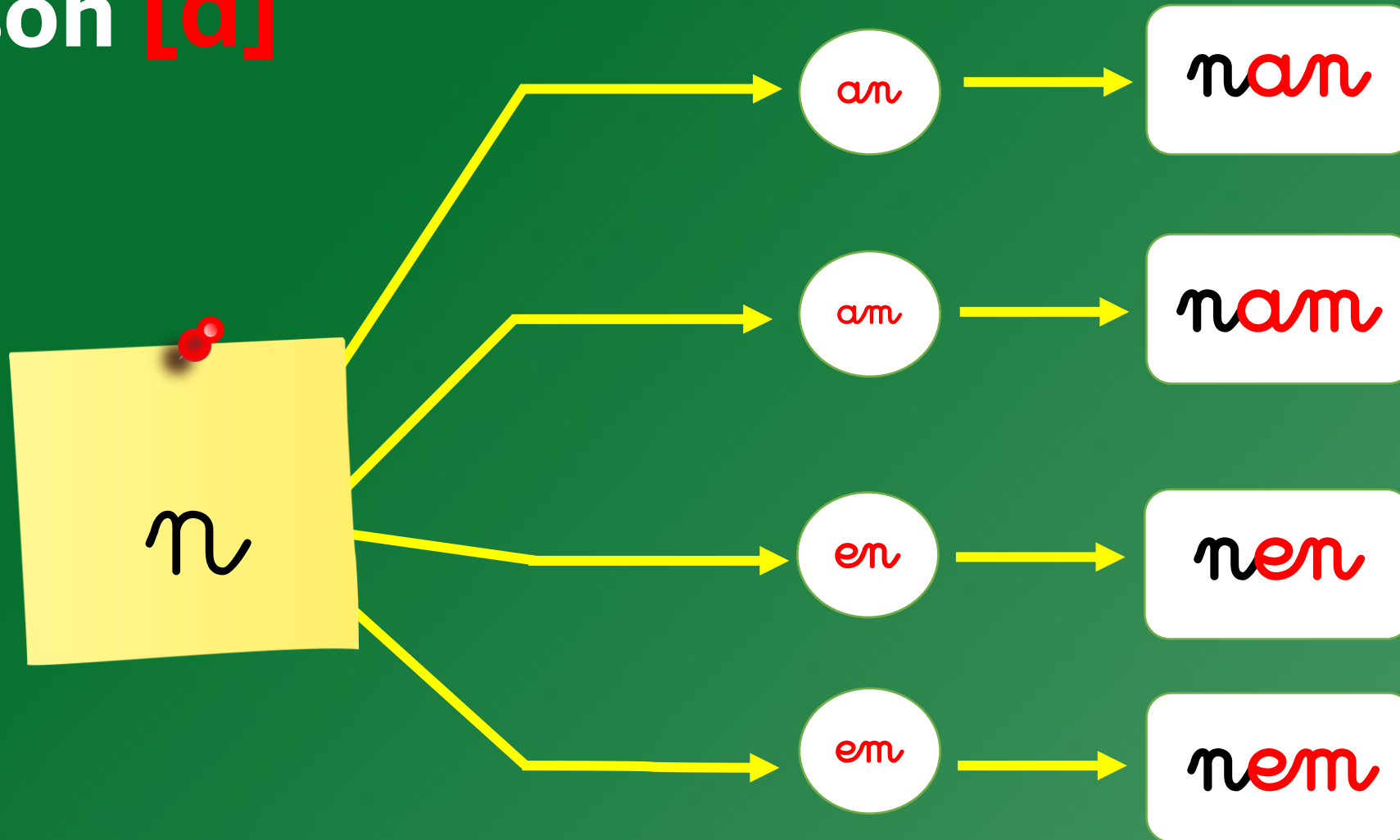

قناة المدرس المغربي



Le son [ɑ]

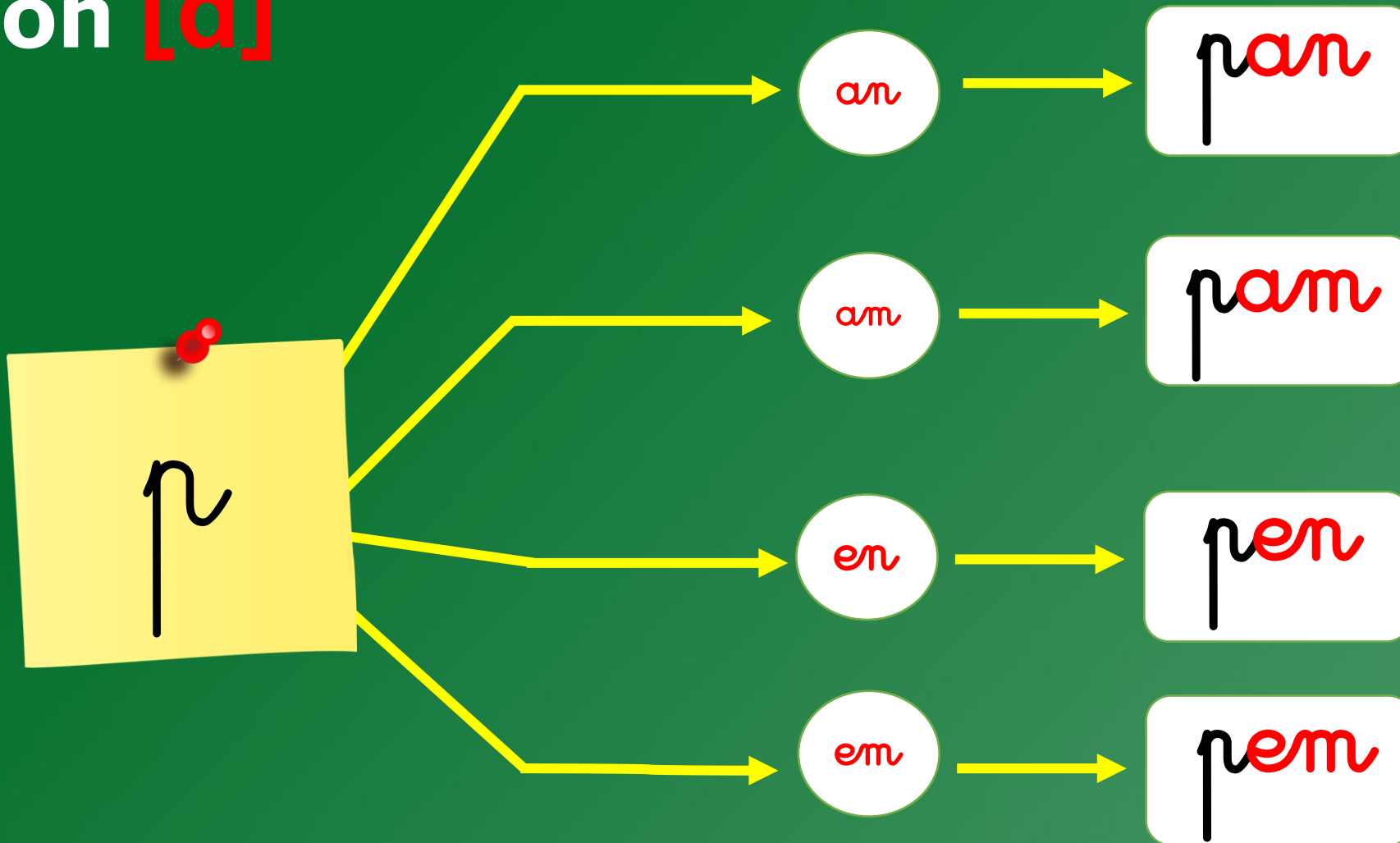

Le son [ɑ]

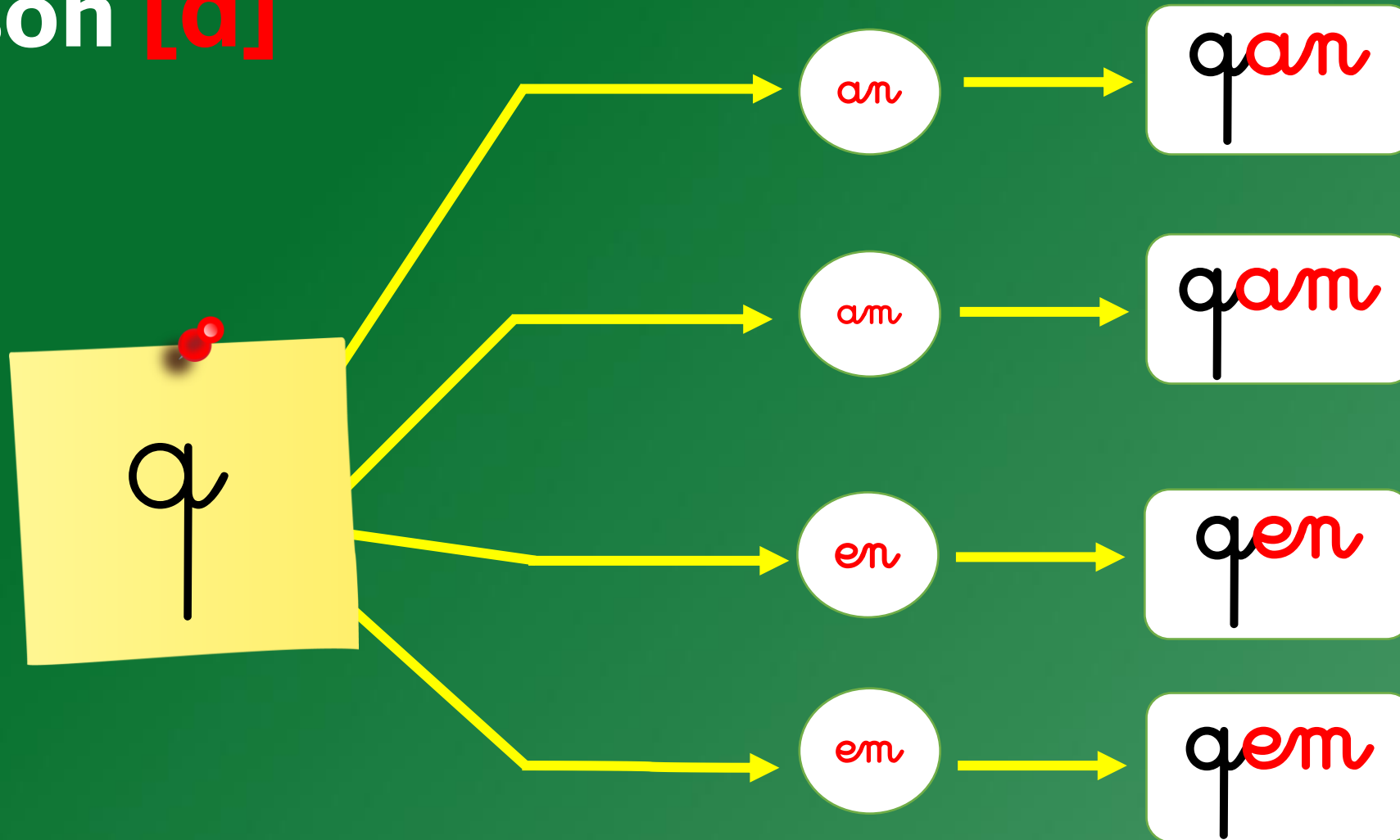

Le son [ɑ]

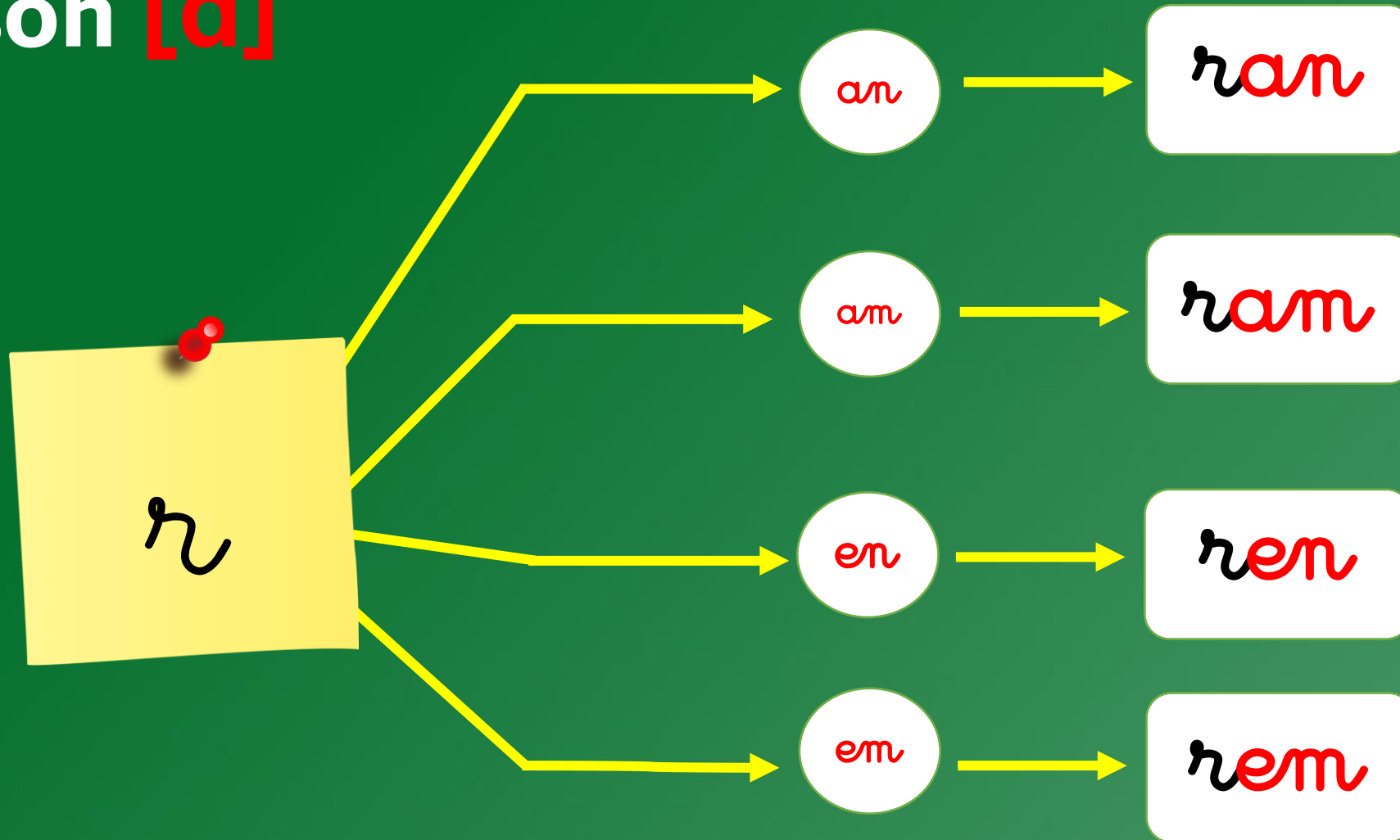

Le son [ɑ]

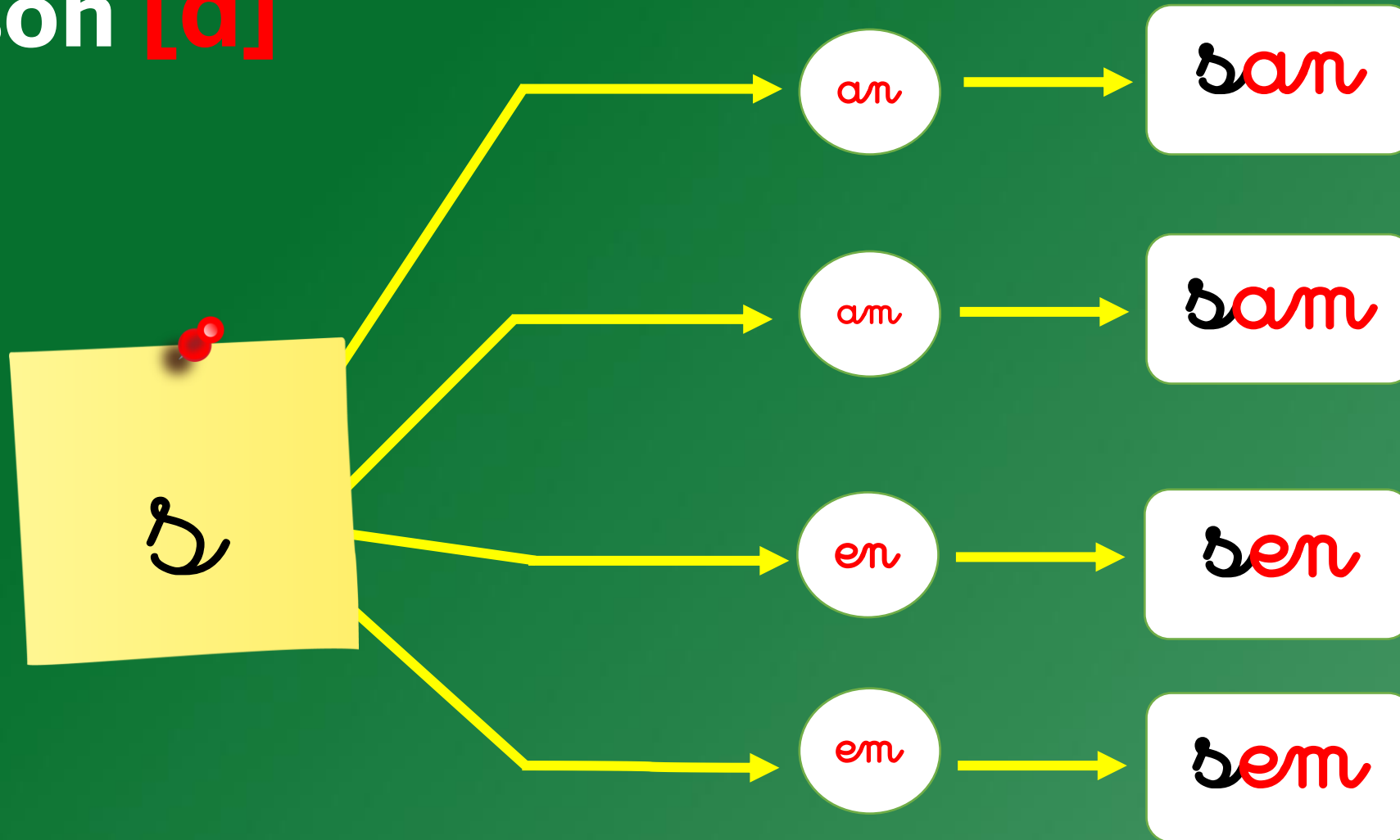

قناة المدرس المغربي



Le son [ɑ]

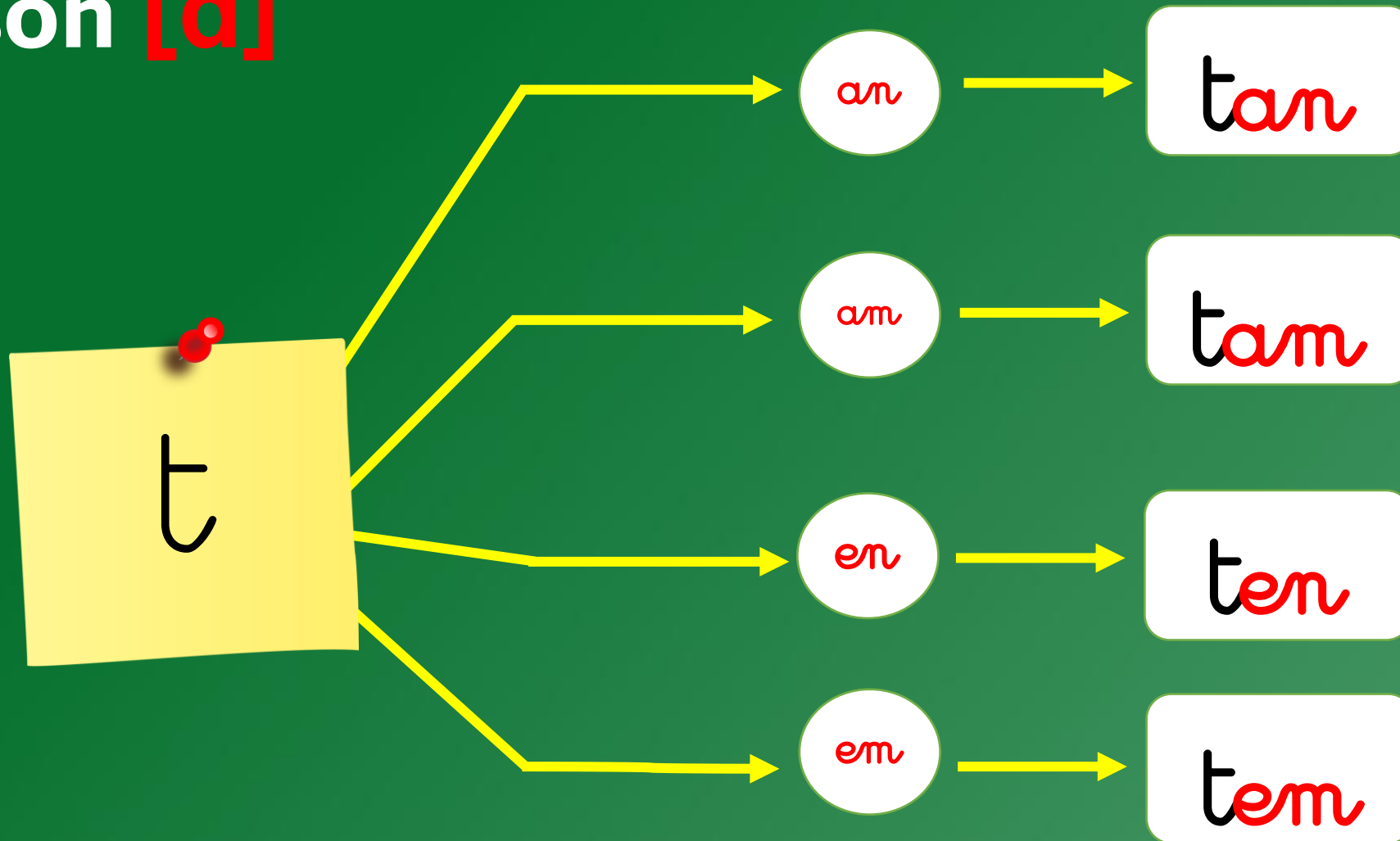

قناة المدرس المغربي



Le son [ɑ]

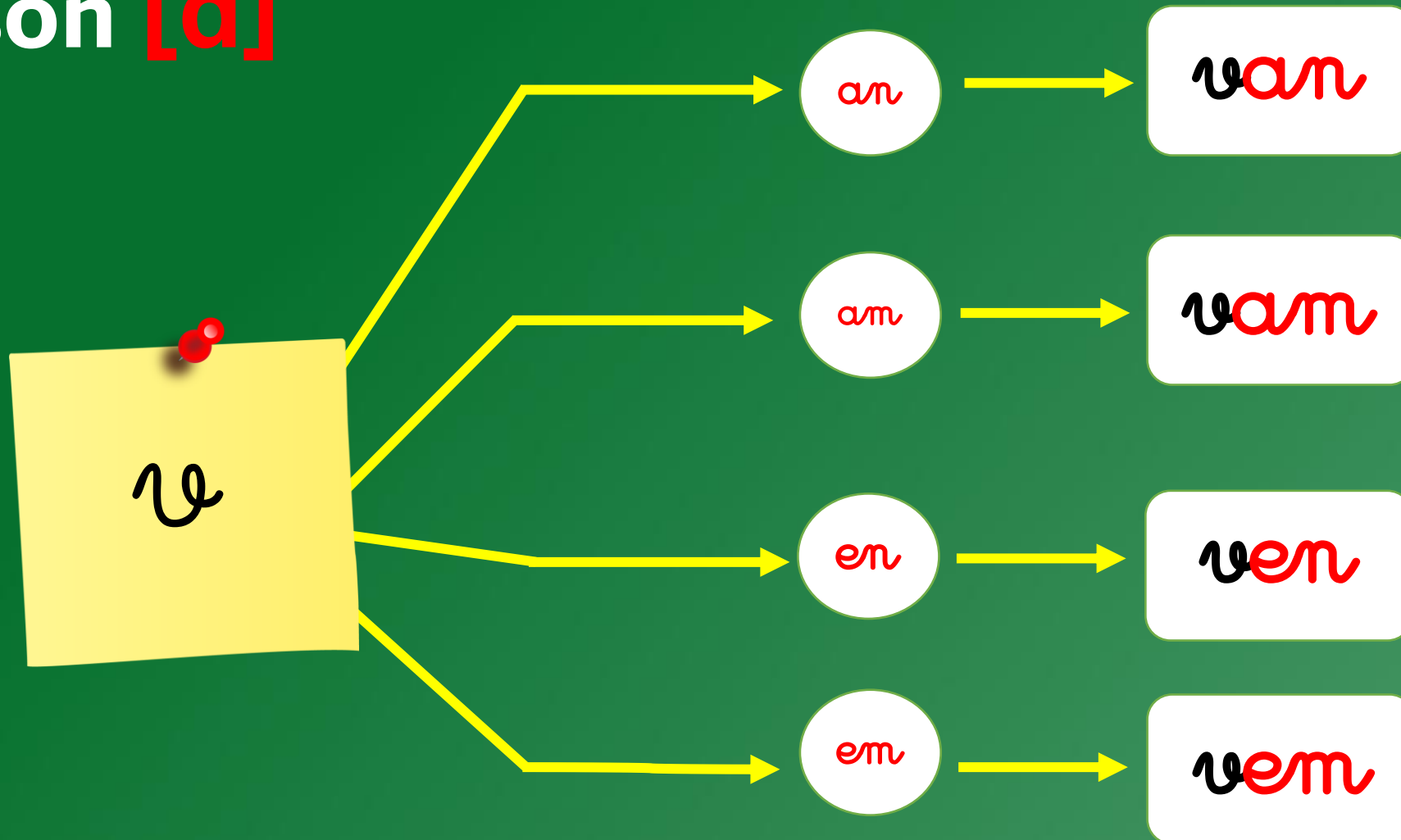

Le son [ɑ]

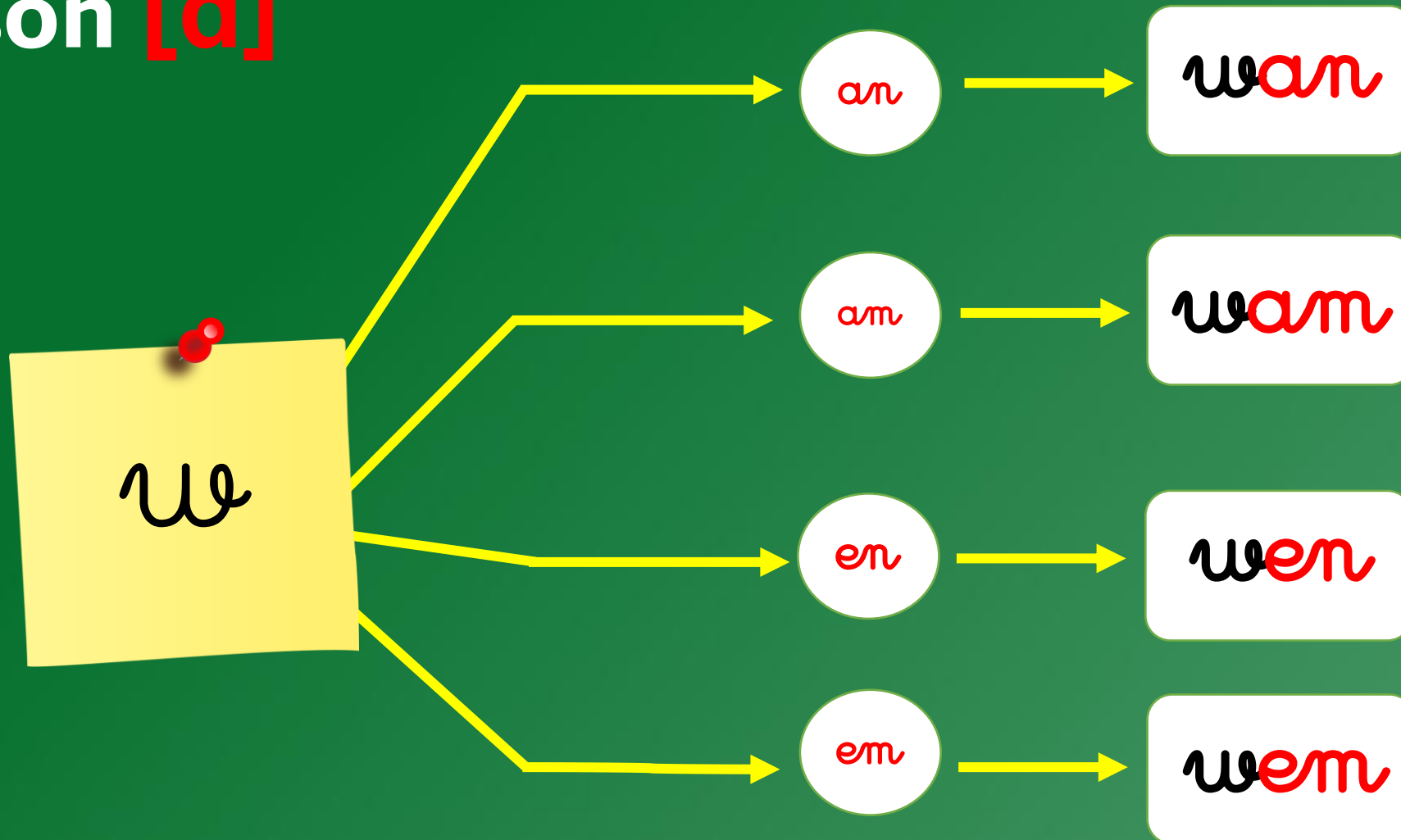

Le son [ɑ]

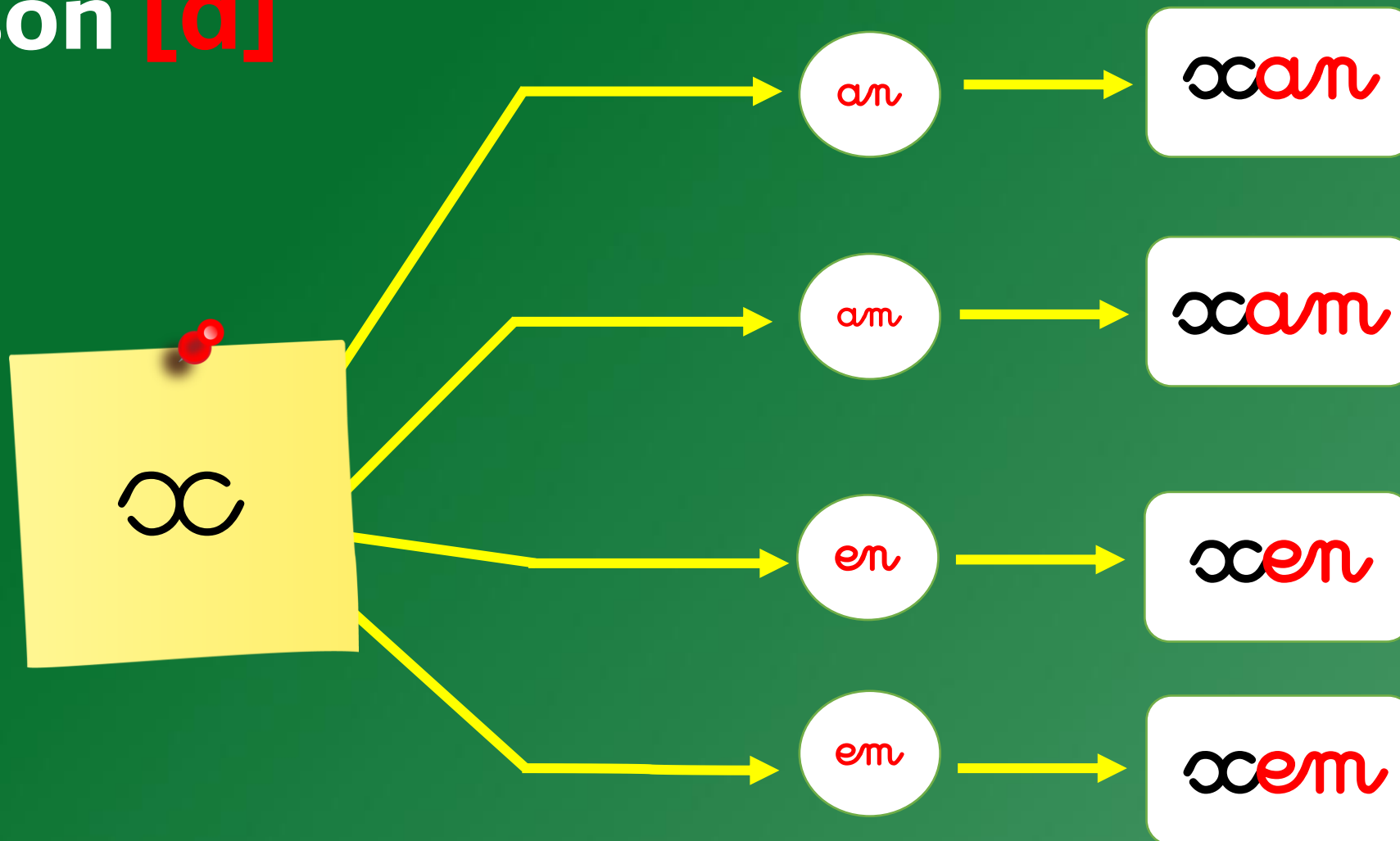

قناة المدرس المغربي



Le son [ɑ]

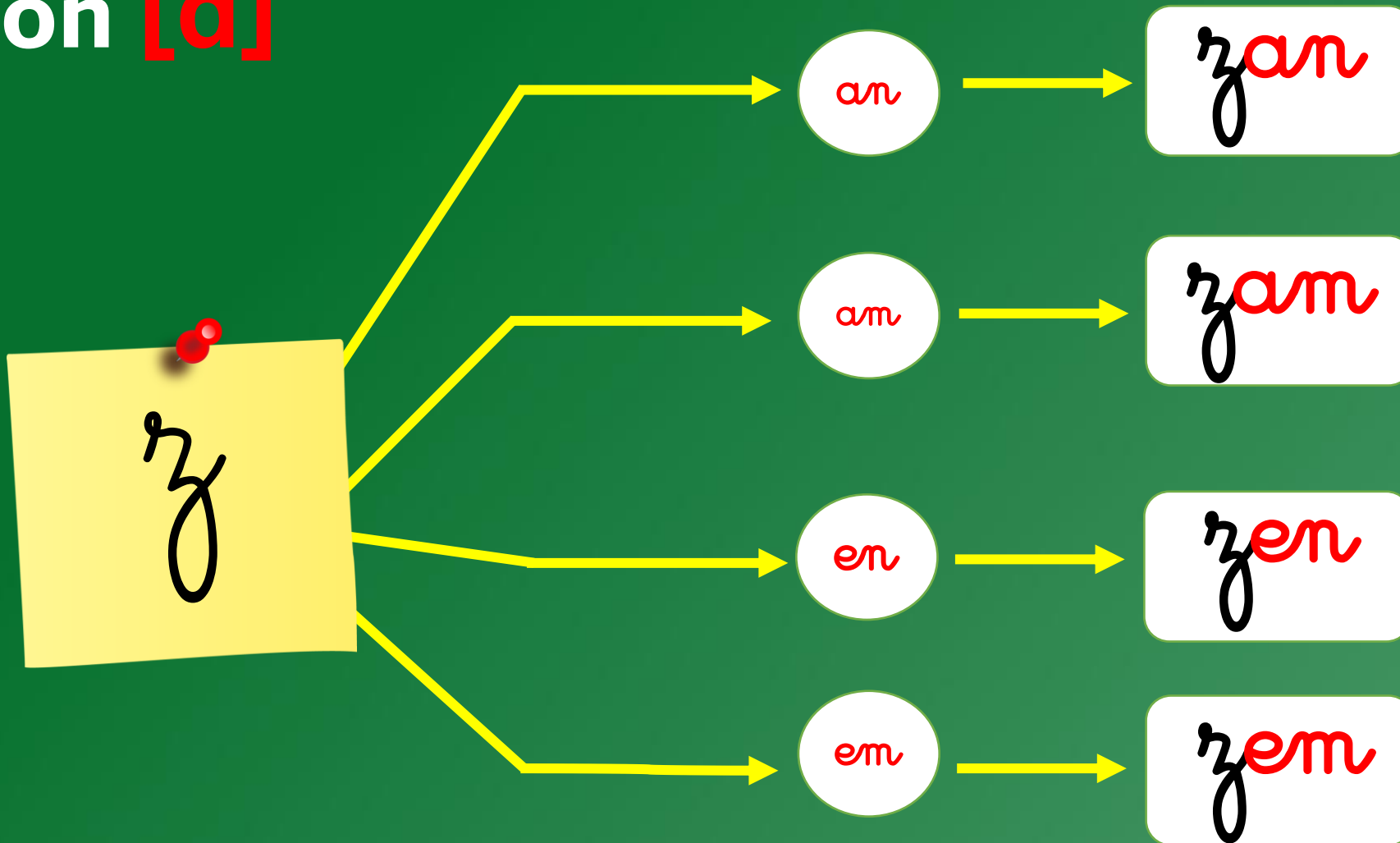

Le son [ɑ]

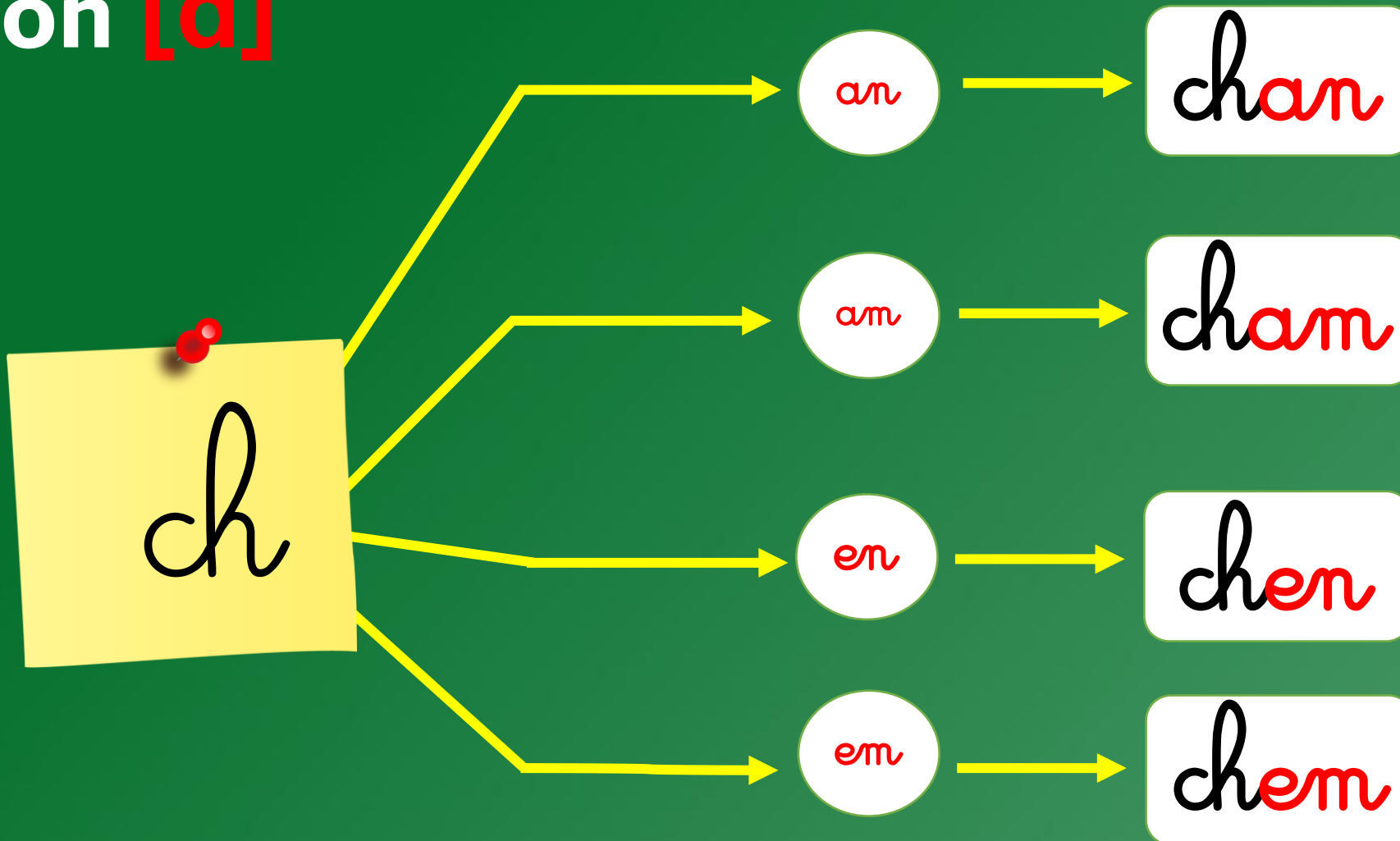

Le son [ɑ]

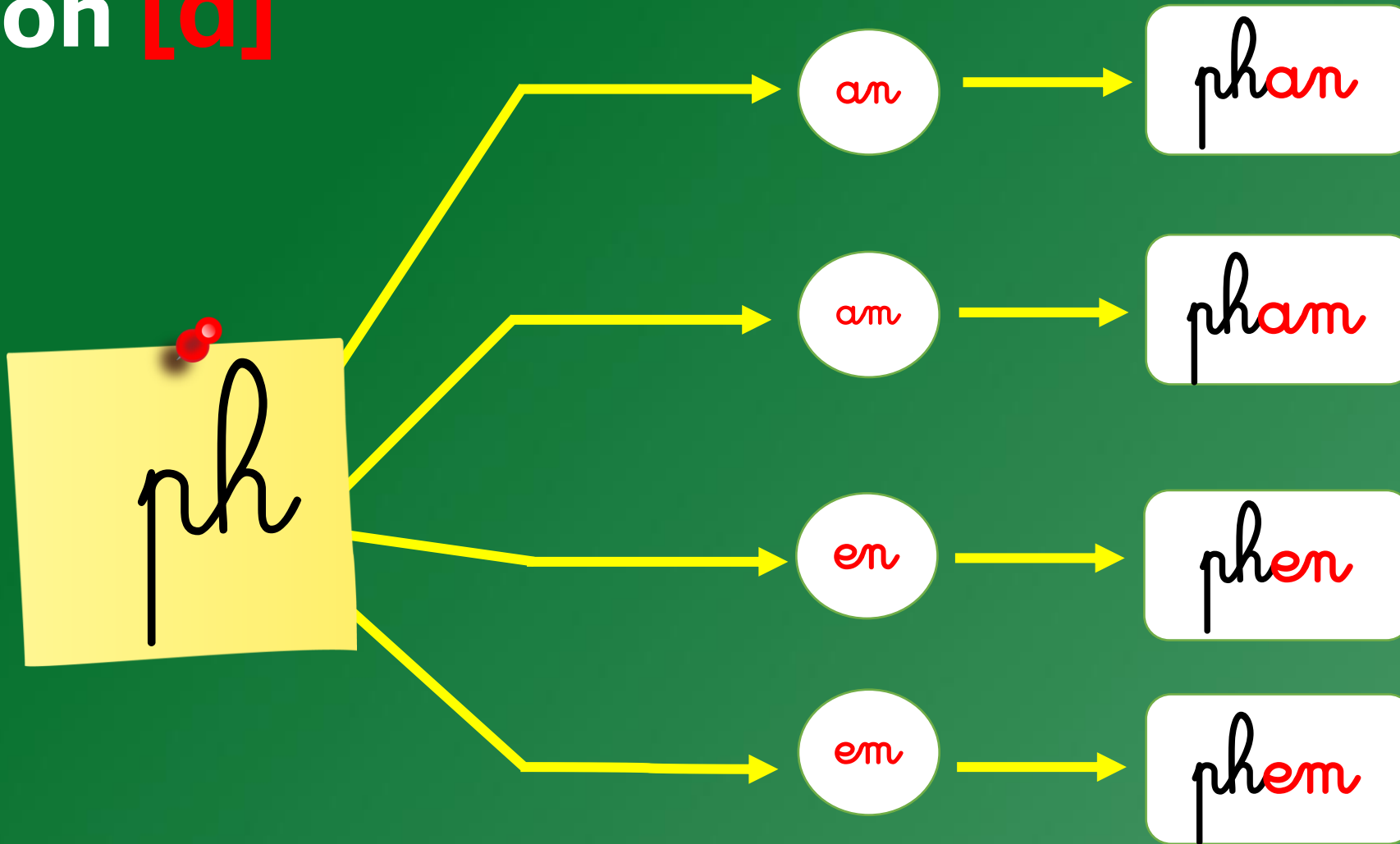

Le son [ɑ]

